



VON DUPRIN®

98/99™ Series Exit Devices

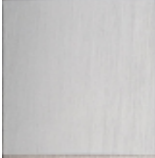
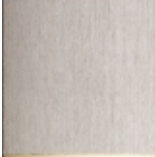

IR Security & Safety
Proven Source. Proven Solutions.™

Finishes*

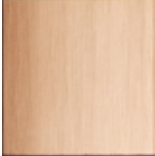
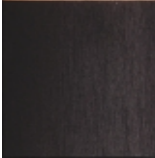
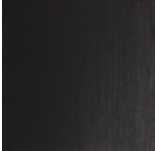
Color	US Number	BHMA Number
	US26	625
	US28	628
	US26D	626
	US3	605
	US4	606
	US10	612
	313AN	710
	315AN	--

Pushpad Options — Knurled
 Embossed "Push"
 Braille (Caution-Stairwell), satin stainless steel only
 SS – (EMERGENCY EXIT – PUSH TO OPEN AND SOUND ALARM) – Red Silkscreen lettering on US32D

* **NOTE:** Durable powder coated finishes available at specific special request. PLEASE CONTACT FACTORY.

Index

	Introduction	3
Exit Hardware	• Rim Devices	
	• 98/99™ Rim Exit Device	4
	• 98/99™ Rim Exit Device Trim	5
	• Mortise Lock Device	
	• 9875/9975 Mortise Lock Device	8
	• 9875/9975 Mortise Lock Device Trim	9
	• Surface Mounted Vertical Rod Devices	
	• 9827/9927 Surface Mounted Vertical Rod Device	12
	• 9827/9927 Surface Mounted Vertical Rod Device Trim	13
	• Three-Point Latching Device	
	• 9857/9957 Three-Point Latching Device	16
	• 9857/9957 Three-Point Latching Device Trim	17
	• Concealed Vertical Rod Device	
	• 9847/9947 Concealed Vertical Rod Device	20
	• 9847/9947 Concealed Vertical Rod Device Trim	21
	• 9848/9948 Concealed Vertical Rod Device	24
	• 9848/9948 Concealed Vertical Rod Device Trim	25
	• Wood Door Concealed Vertical Rod Device	
	• 9847/9947 Wood Door Concealed Vertical Rod Device	28
	• 9847/9947 Wood Door Concealed Vertical Rod Device Trim	29
Fire Exit Hardware	• Fire Exit Rim Devices	
	• 98-F/99-F Rim Exit Device	6
	• 98-F/99-F Rim Exit Device Trim	7
	• Fire Exit Mortise Lock Device	
	• 9875-F/9975-F Fire Exit Mortise Lock Device	10
	• 9875-F/9975-F Fire Exit Mortise Lock Device Trim	11
	• Fire Exit Surface Mounted Vertical Rod Devices	
	• 9827-F/9927-F Surface Mounted Vertical Rod Device	14
	• 9827-F/9927-F Surface Mounted Vertical Rod Device Trim	15
	• Fire Exit Three-Point Latching Device	
	• 9857-F/9957-F Three-Point Latching Device	18
	• 9857-F/9957-F Three-Point Latching Device Trim	19
	• Fire Exit Concealed Vertical Rod Devices	
	• 9847-F/9947-F Concealed Vertical Rod Device	22
	• 9847-F/9947-F Concealed Vertical Rod Device Trim	23
	• 9848-F/9948-F Concealed Vertical Rod Device	26
	• 9848-F/9948-F Concealed Vertical Rod Device Trim	27
	• Fire Exit Wood Door Concealed Vertical Rod Device	
	• 9847-F/9947-F Wood Door Concealed Vertical Rod Device	30
	• 9847-F/9947-F Wood Door Concealed Vertical Rod Device Trim	31
Trim Selection	• Optional Trim	32-34
	• Lever Designs	32
	• Operation Options	35
	• HL Trim	35
	• Vandal Resistant Trim	35
	• CM993 and PRO993 Exit Trim	36
	• How To Order CM993 and PRO993 Exit Trim	37
Strike Selection	• Strikes	39
	• Strike/Stile	38

Index, pg. 2

Device Electrical Options	<ul style="list-style-type: none"> • EL Electric Latch Retraction 43 • E - Electric Rim Device 44 • E7500 Mortise Lock 44 • Chexit 45 • ALK Exit Alarm Kit 42 • SS Signal Switch 43 • LX Latch Bolt Monitoring 42 • RX - Request to Exit 42 • RX2 - Double Request to Exit 42
Device Accessories	<ul style="list-style-type: none"> • Glass Bead Kit 49 • Dummy Push Pad 50 • Cylinders 50 • Cover Plate Kit 49 • RG-27 Vertical Rod and Latch Guard 49
Device Options	<ul style="list-style-type: none"> • Braille, Embossed and Knurled Touchpads 48 • Cylinder Dogging 48 • CDK, HDK Cylinder Dogging and Hex Key Dogging Kits 48 • Pneumatic Controlled Exit Device 48 • Double Cylinder Exit Device 48 • LBR, Less Bottom Rod 49 • PL, Pullman Latch 49
Device Electrical Accessories	<ul style="list-style-type: none"> • Power Supplies <ul style="list-style-type: none"> • PS9 47 • PS861 47 • PS873 46 • EPT Electric Power Transfer 47
Additional Information	<ul style="list-style-type: none"> • ANSI Grade, Type & Function 40 • Device Dimensions 40 • UL Fire Labeling and Opening Size 41 • Finishes 52 • Handing 50 • How-To-Order Information 53 • Nomenclature 53 • Popular Double Door Applications 51

Introduction

Exit devices are a critical part of the Fire and Life Safety egress system and will provide safe and reliable service when properly applied and maintained. Von Duprin designs and manufactures exit devices in accordance to ISO 9001 Quality Management System and meets or exceeds accepted U.S. domestic and International standards. All 98 and 99 series exit devices are UL listed for Panic Hardware or Fire Hardware, and are certified to ANSI A156.3, 2001, Grade 1. Many models are also certified for Hurricane Resistant Applications. Consult your local IR Security & Safety consultant or the Von Duprin factory for current listings.

It is intended that the information included in this publication, when properly used, will provide clear and reliable guidelines to the proper general selection and application. However, the scope of the information is necessarily limited.

Unusual operating conditions and environments and other external influences can affect the proper application of the products represented. Modifications of these products will also affect UL listings. It is recommended that whenever an unusual application condition exists, or when any modification of a product is considered, that our engineers review the application.

Application engineering services are available to help ensure proper selection or to review any areas where users of Von Duprin products may have questions.



99 Series features grooved mechanism case.

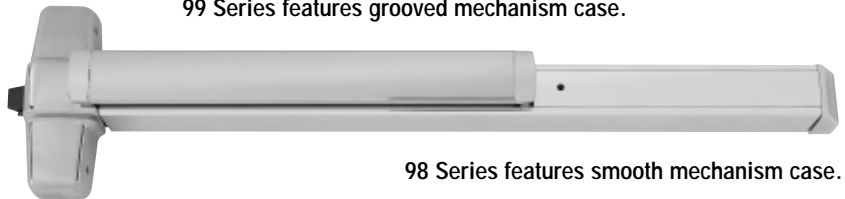

98 Series features smooth mechanism case.

Von Duprin push pad exit devices are available in two external surface styles, designated 98 Series and 99 Series. The two styles are mechanically and dimensionally identical and provide a wide selection of appearance options.

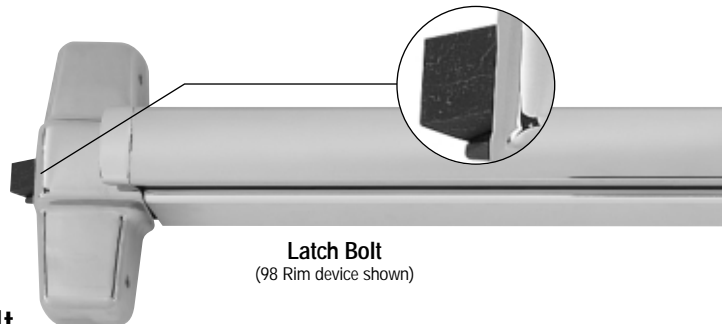

Latch Bolt

Deadlocking latchbolt provides security and improved performance at standard device cost.

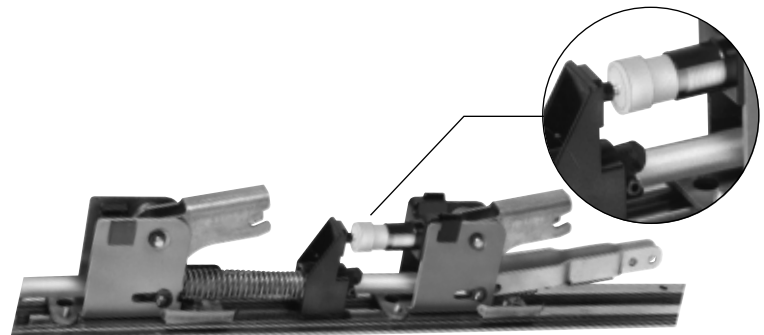

The Quiet One®

A fluid dampener decelerates the pushpad on its return stroke and eliminates most noise associated with exit device operations. Furnished on all 98/99™ series exit devices.



299 Strike

98 and 99 rim exit devices for all types of single and double doors with mullion, UL listed for Panic Exit Hardware. Devices are ANSI A156.3 – 2001 Grade 1. The 98 device has a smooth mechanism case and the 99 device has a grooved case. The rim device is non-handed except when the following device options are used: SD (Special Dogging), -2 (Double Cylinder) or SS (Signal Switch). See Opposite page for available outside trim and device functions. Covers stock hollow metal doors with 86 or 161 cutouts on single doors (may cover cutouts on pairs – consult template).



The 98/99 devices are available in the following finishes: US3, US4, US10, US26, US26D, US28, 313AN, 315AN and US32D for the 98 device only. See page 52 for component finishes and the inside cover for finish chips.





Specifications

Device Functions	Device ships EO/DT/NL. Field selectable. For TP,K,or L remove NL drive screw from device		
Device Lengths	3'	2'4" to 3' (711mm to 914 mm)	Door Size
	4'	2'10" to 4' (864 mm to 1219 mm)	Door Size
Strikes	299 – Dull Black Optional Strikes – see page 39		
Dogging Feature	Hex key dogging standard		
Dogging Options	CD	Cylinder Dogging	see page 48
	SD	Special Center Case Dogging	see page 48
	LD	Less Dogging	see page 48
Electric Options	LX	Latchbolt Monitor Switch	see page 42
	RX	Pushpad Monitor Switch	see page 42
	RX2	Double Pushpad Monitor Switch	see page 42
	E	Electric Locking & Unlocking	see page 44
	EL	Electric Latch Retraction	see page 43
	SS	Signal Switch	see page 43
	CX	Chexit Delayed Exit	see page 45
	ALK	Alarm Exit Kit	see page 42
Miscellaneous Options	PN	Pneumatic Latch Retraction	see page 48
	-2	Double Cylinder	see page 48
	GBK	Glass Bead Kit	see page 49
Fasteners & Sex Bolts (SNB)	Includes 1 ¾" (19mm) – 2 ¼" (57mm) Wood & Metal Doors Optional SNB available for device, see next page for quantities		
Latch Bolt	Deadlocking, ¾" (19mm) throw		
Device Centerline from Finished Floor	39 13/16" (1011 mm) 39 11/16" (1008 mm) with Mullion		
Center Case Dimensions	8" x 2 ¾" x 2 3/8" (203mm x 70mm x 60mm)		
Mechanism Case Dimensions	2 ¼" x 2 ¼" (57mm x 57mm)		
Projection	Pushbar Neutral – 3 13/16" (97 mm) Pushbar Depressed – 3 1/16" (78 mm)		

See page 53 for How to Order specification

VON DUPRIN® 98/99™ Rim Exit Device Standard Trim

	Exit only	Dummy Trim Pull when Dogged	Night Latch Key Retracts Latchbolt	Night Latch Key Retracts Latchbolt Optional Pull Required
				
Product Description	98EO 99EO	98DT 99DT	98NL 99NL	98NL-OP 99NL-OP
Trim Description	---	990DT	990NL-R/V	110NL-MD 110NL-WD
Escutcheon Plate Size	---	3" x 14 ³ / ₁₆ " x ³ / ₃₂ " (76x360x2mm)	3" x 14 ³ / ₁₆ " x ³ / ₃₂ " (76x360x2mm)	---
Pull Center to Center	---	5 ¹ / ₂ " (140mm)	5 ¹ / ₂ " (140mm)	---
Projection	---	2" (51mm)	2" (51mm)	---
ANSI Function	01	02	03	03
Cylinder Type	---	---	Rim	Rim
Optional Trim (See pages 32 – 34)	x990EO x992EO x994EO x996EO	x991K-DT x992L-DT x994L-DT x996L-DT x696DT x697DT	x991K-NL x992L-NL x994L-NL x996L-NL x696NL x697NL	
Optional #425 Sex Bolt Quantity for Device	6	2	2	6

	Lever Key Locks & Unlocks	Lever – Night Latch Key Retracts Latchbolt	Lever – Blank Escutcheon Always operable (No Cylinder)	Lever Dummy Trim Pull when Dogged
				
Product Description	98L 99L	98L-NL 99L-NL	98L-BE 99L-BE	98L-DT 99L-DT
Trim Description	996L-R/V	996L-NL-R/V	996L-BE-R/V	996L-DT-RV
Escutcheon Plate Size	2 ³ / ₄ " x 10 ³ / ₄ " x ²⁷ / ₃₂ " (70x273x21mm)	2 ³ / ₄ " x 10 ³ / ₄ " x ²⁷ / ₃₂ " (70x273x21mm)	2 ³ / ₄ " x 10 ³ / ₄ " x ²⁷ / ₃₂ " (70x273x21mm)	2 ³ / ₄ " x 10 ³ / ₄ " x ²⁷ / ₃₂ " (70x273x21mm)
Pull Center to Center	---	---	---	---
Projection	2 ⁷ / ₈ " (73mm)	2 ⁷ / ₈ " (73mm)	2 ⁷ / ₈ " (73mm)	2 ⁷ / ₈ " (73mm)
ANSI Function	08	09	---	02
Cylinder Type	Rim	Rim	---	---
Optional Trim (See pages 32 – 34)	x992L x994L	x992L-NL x994L-NL	x992L-BE x994L-BE	x992L-DT x994L-DT
Optional #425 Sex Bolt Quantity for Device	2	2	2	2

For optional trims and functions see pages 32-34

VON DUPRIN® 98-F/99-F Rim Fire Exit Device



299F Strike



499F Strike
With 9854/9954
Mullion

98-F and 99-F rim fire exit devices for all types of single doors up to 4' x 10' (1219mm x 3048mm) or 8' x 10' (2438mm x 3048mm) double doors with 9954 or 9854 mullion, UL listed for Fire Exit Hardware. See page 41 for detailed information on UL listed fire exit hardware label and door opening size information. Devices are ANSI A156.3 – 2001 Grade 1. The 98-F device has a smooth mechanism case and the 99-F device has a grooved case. The rim device is non-handed except when the following device options are used: -2 (Double Cylinder) or SS (Signal Switch). See Opposite page for available outside trim and device functions.

The 98-F/99-F devices are available in the following finishes: US3, US4, US10, US26, US26D, US28, 313AN, 315AN and US32D for the 98-F device only. See page 52 for component finishes and the inside cover for finish chips.

Specifications

Device Functions	Device ships EO/DT/NL. Field selectable. For TP,K,or L remove NL drive screw from device		
Device Lengths	3'	2'4" to 3'	(711mm to 914 mm) Door Size
	4'	2'10" to 4'	(864 mm to 1219 mm) Door Size
Strikes	299F – Dull Black, 499F with Mullions Optional Strikes – see page 39		
Dogging Feature	No Mechanical Dogging, EL option available		
Electric Options	LX	Latchbolt Monitor Switch	see page 42
	RX	Pushpad Monitor Switch	see page 42
	RX2	Double Pushpad Monitor Switch	see page 42
	E	Electric Locking & Unlocking	see page 44
	EL	Electric Latch Retraction	see page 43
	SS	Signal Switch	see page 43
	CX	Chexit Delayed Exit	see page 45
	ALK	Alarm Exit Kit	see page 42
Miscellaneous Options	PN	Pneumatic Latch Retraction	see page 48
	-2	Double Cylinder	see page 48
	GBK	Glass Bead Kit	see page 49
Fasteners & Sex Bolts (SNB)	Includes 1 ¾" (19mm) – 2 ¼" (57mm) Wood & Metal Doors Optional SNB available for device, see next page for quantities Optional SLM Blocking Pkg for wood doors with SLM blocking SNB required for wood doors, unless SLM Blocking Pkg specified		
Latch Bolt	Deadlocking, ¾" (19mm) throw		
Device Centerline from Finished Floor	39 13/16"	(1011 mm)	
	39 11/16"	(1008 mm) with Mullion	
Center Case Dimensions	8" x 2 ¾" x 2 ¾" (203mm x 70mm x 60mm)		
Mechanism Case Dimensions	2 ¼" x 2 ¼" (57mm x 57mm)		
Projection	Pushbar Neutral – 3 13/16" (97 mm) Pushbar Depressed – 3 1/16" (78 mm)		

See page 53 for How to Order specification

VON DUPRIN® 98-F/99-F Fire Exit Rim Device Standard Trim

	Exit only	Dummy Trim Pull when Dogged (Not recommended for Fire Device)	Night Latch Key Retracts Latchbolt	Night Latch Key Retracts Latchbolt Optional Pull Required
Product Description	98EO-F 99EO-F	-- --	98NL-F 99NL-F	98NL-OP-F 99NL-OP-F
Trim Description	--	990DT	990NL-R/V	110NL-MD 110NL-WD
Escutcheon Plate Size	--	3" x 14 ⁹ / ₁₆ " x ³ / ₃₂ " (76x360x2mm)	3" x 14 ⁹ / ₁₆ " x ³ / ₃₂ " (76x360x2mm)	--
Pull Center to Center	--	5 ¹ / ₂ " (140mm)	5 ¹ / ₂ " (140mm)	--
Projection	--	2" (51mm)	2" (51mm)	--
ANSI Function	01	02	03	03
Cylinder Type	--	--	Rim	Rim
Optional Trim (See pages 32 – 34)	x990EO x992EO x994EO x996EO	x991K-DT x992L-DT x994L-DT x996L-DT x696DT x697DT	x991K-NL x992L-NL x994L-NL x996L-NL x696NL x697NL	
#425 SNB optional-HMD Req. WD w/o SLM Pkg.	6	2	2	6
#825 SNB Req. WD w/o SLM Pkg.	2	2	2	2
#425 SNB Req. w/ 499F	2	2	2	2

	Lever Key Locks & Unlocks	Lever – Night Latch Key Retracts Latchbolt	Lever – Blank Escutcheon Always operable (No Cylinder)	Lever Dummy Trim Pull when Dogged (Not recommended for Fire Device)
Product Description	98L-F 99L-F	98L-NL-F 99L-NL-F	98L-BE-F 99L-BE-F	-- --
Trim Description	996L-R/V	996L-NL-R/V	996L-BE-R/V	996L-DT-R/V
Escutcheon Plate Size	2 ³ / ₄ " x 10 ³ / ₄ " x ²⁷ / ₃₂ " (70x273x21mm)	2 ³ / ₄ " x 10 ³ / ₄ " x ²⁷ / ₃₂ " (70x273x21mm)	2 ³ / ₄ " x 10 ³ / ₄ " x ²⁷ / ₃₂ " (70x273x21mm)	2 ³ / ₄ " x 10 ³ / ₄ " x ²⁷ / ₃₂ " (70x273x21mm)
Pull Center to Center	--	--	--	--
Projection	2 ⁷ / ₈ " (73mm)	2 ⁷ / ₈ " (73mm)	2 ⁷ / ₈ " (73mm)	2 ⁷ / ₈ " (73mm)
ANSI Function	08	09	--	02
Cylinder Type	Rim	Rim	--	--
Optional Trim (See pages 32 – 34)	x992L x994L	x992L-NL x994L-NL	x992L-BE x994L-BE	x992L-DT x994L-DT
#425 SNB optional-HMD Req. WD w/o SLM Pkg.	2	2	2	2
#825 SNB Req. WD w/o SLM Pkg.	2	2	2	2
#425 SNB Req. w/ 499F	2	2	2	2

For optional trims and functions see pages 32-34

VON DUPRIN® 9875/9975 Mortise Lock Device

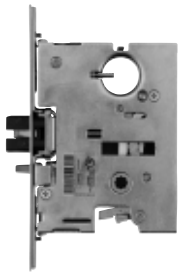

575 Strike

9875/9975 mortise lock device for all types of single or double doors, UL listed for Panic Exit Hardware. Devices are ANSI A156.3 – 2001 Grade 1. Fits stock hollow metal doors with 86 cutout and door stiles as narrow as 4 3/4" (121mm). The 9875 device has a smooth mechanism case and the 9975 device has a grooved case. The mortise lock device is non-handed except when the following device options are used: -2 (Double Cylinder) or SS (Signal Switch). See Opposite page for available outside trim and device functions.

The 9875/9975 devices are available in the following finishes: US3, US4, US10, US26, US26D, US28, 313AN, 315AN and US32D for the 9875 device only. See page 52 for component finishes and the inside cover for finish chips.



The 7500 Mortise lock is equipped with a 3/4" (19mm) anti-friction latch bolt which is field reversible without removing the lock from the door. It has a non-handed auxiliary bolt for deadlocking and a faceplate with an adjustable bevel.





Specifications

Device Functions	Device ships EO/DT/NL. Field selectable. For TP,K, or L adjust NL drive screw in mortise lock		
Device Lengths	3'	2'4" to 3' (711mm to 914 mm) Door Size	
	4'	2'10" to 4' (864 mm to 1219 mm) Door Size	
Strikes	575 – Dull Black Optional Strikes – see page 39		
Dogging Feature	Hex key dogging standard		
Dogging Options	CD	Cylinder Dogging	see page 48
	LD	Less Dogging	see page 48
Electric Option	RX	Pushpad Monitor Switch	see page 42
	RX2	Double Pushpad Monitor Switch	see page 42
	E	Electric Locking & Unlocking	see page 44
	EL	Electric Latch Retraction	see page 43
	SS	Signal Switch	see page 43
	CX	Chexit Delayed Exit	see page 45
	ALK	Alarm Exit Kit	see page 42
Miscellaneous Options	PN	Pneumatic Latch Retraction	see page 48
	-2	Double Cylinder	see page 48
	GBK	Glass Bead Kit	see page 49
Fasteners & Sex Bolts (SNB)	Includes 1 3/4" (19mm) – 2 1/4" (57mm) Wood & Metal Doors Optional SNB available for device, see next page for quantities		
Device Centerline from Finished Floor	39 5/8" (1006 mm)		
Center Case Dimensions	8" x 2 3/4" x 2 3/8" (203mm x 70mm x 60mm)		
Mechanism Case Dimensions	2 1/4" x 2 1/4" (57mm x 57mm)		
Projection	Pushbar Neutral – 3 13/16" (97 mm) Pushbar Depressed – 3 1/16" (78 mm)		

See page 53 for How to Order specification

VON DUPRIN® 9875/9975 Mortise Lock Device Standard Trim

	Exit only	Dummy Trim Pull when Dogged	Night Latch Key Retracts Latchbolt	Hospital Latch Key Locks & Unlocks
				
Product Description	9875EO 9975EO	9875DT 9975DT	9875NL 9975NL	9875HL 9975HL
Trim Description	---	990DT	990NL-M	HL6M
Escutcheon Plate Size	---	3" x 14 ³ / ₁₆ " x 3 ³ / ₃₂ " (76x360x2mm)	3" x 14 ³ / ₁₆ " x 3 ³ / ₃₂ " (76x360x2mm)	2 ⁹ / ₁₆ " x 5 ¹ / ₂ " x 2 ⁵ / ₈ " (65x140x67mm)
Pull Center to Center	---	5 ¹ / ₂ " (140mm)	5 ¹ / ₂ " (140mm)	---
Projection	---	2" (51mm)	2" (51mm)	2 ⁵ / ₈ " (67mm)
ANSI Function	01	02	03	---
Cylinder Type	---	---	1 ¹ / ₄ " Mortise	1 ¹ / ₄ " Mortise
Optional Trim (See pages 32 – 34)	x990EO x992EO x994EO x996EO	x991K-DT x992L-DT x994L-DT x996L-DT x696DT x697DT	x991K-NL x992L-NL x994L-NL x996L-NL x696NL x697NL	
Optional #425 Sex Bolt Quantity for Device	6	2	2	2

	Lever Key Locks & Unlocks	Lever – Night Latch Key Retracts Latchbolt	Lever – Blank Escutcheon Always operable (No Cylinder)	Lever Dummy Trim Pull when Dogged
				
Product Description	9875L 9975L	9875L-NL 9975L-NL	9875L-BE 9975L-BE	9875L-DT 9975L-DT
Trim Description	996L-M	996L-NL-M	996L-BE-M	996L-DT-M
Escutcheon Plate Size	2 ³ / ₄ " x 10 ³ / ₄ " x 2 ⁷ / ₃₂ " (70x273x21mm)	2 ³ / ₄ " x 10 ³ / ₄ " x 2 ⁷ / ₃₂ " (70x273x21mm)	2 ³ / ₄ " x 10 ³ / ₄ " x 2 ⁷ / ₃₂ " (70x273x21mm)	2 ³ / ₄ " x 10 ³ / ₄ " x 2 ⁷ / ₃₂ " (70x273x21mm)
Pull Center to Center	---	---	---	---
Projection	2 ⁷ / ₈ " (73mm)	2 ⁷ / ₈ " (73mm)	2 ⁷ / ₈ " (73mm)	2 ⁷ / ₈ " (73mm)
ANSI Function	08	09	---	02
Cylinder Type	1 ¹ / ₄ " Mortise	1 ¹ / ₄ " Mortise	---	---
Optional Trim (See pages 32 – 34)	x992L x994L	x992L-NL x994L-NL	x992L-BE x994L-BE	x992L-DT x994L-DT
Optional #425 Sex Bolt Quantity for Device	2	2	2	2

For optional trims and functions see pages 32-34

VON DUPRIN® 9875-F/9975-F Mortise Lock Fire Exit Device

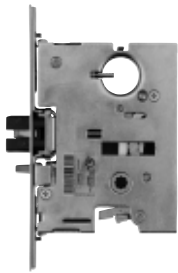

575 Strike

9875-F/9975-F fire exit mortise lock devices for all types of single doors up to 4' x 10' (1219mm x 3048mm) or 8' x 10' (2438mm x 3048mm) double doors installations, UL listed for Fire Exit Hardware; **See page 41 for detailed information on UL listed fire exit hardware label and door opening size information.** Devices are ANSI A156.3 – 2001 Grade 1. Fits door stiles as narrow as 4 3/4" (121mm). The 9875-F device has a smooth mechanism case and the 9975-F device has a grooved case. The mortise lock device is non-handed except when the following device options are used: -2 (Double Cylinder) or SS (Signal Switch) devices. See Opposite page for available outside trim and functions.

The 9875-F/9975-F devices are available in the following finishes: US3, US4, US10, US26, US26D, US28, 313AN, 315AN and US32D for the 9875-F device only. See page 52 for component finishes and the inside cover for finish chips.



The 7500 Mortise lock is equipped with a 3/4" (19mm) anti-friction latch bolt which is field reversible without removing the lock from the door. It has a non-handed auxiliary bolt for deadlocking and a faceplate with an adjustable bevel.





Specifications

Device Functions	Device ships EO/DT/NL. Field selectable. For TP,K,or L remove NL drive screw from device		
Device Lengths	3'	2'4" to 3'	(711mm to 914 mm) Door Size
	4'	2'10" to 4'	(864 mm to 1219 mm) Door Size
Strikes	575 – Dull Black Optional Strikes – see page 39		
Dogging Feature	No Mechanical Dogging, EL option available		
Electric Options	RX	Pushpad Monitor Switch	see page 42
	RX2	Double Pushpad Monitor Switch	see page 42
	E	Electric Locking & Unlocking	see page 44
	EL	Electric Latch Retraction	see page 43
	SS	Signal Switch	see page 43
	CX	Chexit Delayed Exit	see page 45
	ALK	Alarm Exit Kit	see page 42
Miscellaneous Options	PN	Pneumatic Latch Retraction	see page 48
	-2	Double Cylinder	see page 48
	GBK	Glass Bead Kit	see page 49
Fasteners & Sex Bolts (SNB)	Includes 1 3/4" (19mm) – 2 1/4" (57mm) Wood & Metal Doors Optional SNB available for device, see next page for quantities Optional SLM Blocking Pkg for wood doors with SLM blocking SNB required for wood doors, unless SLM Blocking Pkg. specified		
Device Centerline from Finished Floor	39 5/8" (1006 mm)		
Center Case Dimensions	8" x 2 3/4" x 2 3/8" (203mm x 70mm x 60mm)		
Mechanism Case Dimensions	2 1/4" x 2 1/4" (57mm x 57mm)		
Projection	Pushbar Neutral – 3 13/16" (97 mm) Pushbar Depressed – 3 1/16" (78 mm)		

See page 53 for How to Order specification

VON DUPRIN® 9875-F/9975-F Mortise Lock Fire Exit Device Standard Trim

	Exit only	Dummy Trim Pull when Dogged (Not recommended for Fire Device)	Night Latch Key Retracts Latchbolt	Hospital Latch Key Locks & Unlocks
				
Product Description	9875EO-F 9975EO-F	-- --	9875NL-F 9975NL-F	9875HL-F 9975HL-F
Trim Description	--	990DT	990NL-R/V	HL6M
Escutcheon Plate Size	--	3" x 14 ³ / ₁₆ " x ³ / ₃₂ " (76x360x2mm)	3" x 14 ³ / ₁₆ " x ³ / ₃₂ " (76x360x2mm)	2 ⁹ / ₁₆ " x 5 ¹ / ₂ " x 2 ⁵ / ₈ " (65x140x67mm)
Pull Center to Center	--	5 ¹ / ₂ " (140mm)	5 ¹ / ₂ " (140mm)	--
Projection	--	2" (51mm)	2" (51mm)	2 ⁵ / ₈ " (67mm)
ANSI Function	01	02	03	--
Cylinder Type	--	--	1 ¹ / ₄ " Mortise	1 ¹ / ₄ " Mortise
Optional Trim (See pages 32 – 34)	x990EO x992EO x994EO x996EO	x991K-DT x992L-DT x994L-DT x996L-DT x696DT x697DT	x991K-NL x992L-NL x994L-NL x996L-NL x696NL x697NL	
#425 SNB optional-HMD Req. WD w/o SLM Pkg.	6	2	2	2

	Lever Key Locks & Unlocks	Lever – Night Latch Key Retracts Latchbolt	Lever – Blank Escutcheon Always operable (No Cylinder)	Lever Dummy Trim Pull when Dogged (Not recommended for Fire Device)
				
Product Description	9875L-F 9975L-F	9875L-NL-F 9975L-NL-F	9875L-BE-F 9975L-BE-F	-- --
Trim Description	996L-M	996L-NL-M	996L-BE-M	996L-DT-M
Escutcheon Plate Size	2 ³ / ₄ " x 10 ³ / ₄ " x ²⁷ / ₃₂ " (70x273x21mm)	2 ³ / ₄ " x 10 ³ / ₄ " x ²⁷ / ₃₂ " (70x273x21mm)	2 ³ / ₄ " x 10 ³ / ₄ " x ²⁷ / ₃₂ " (70x273x21mm)	2 ³ / ₄ " x 10 ³ / ₄ " x ²⁷ / ₃₂ " (70x273x21mm)
Pull Center to Center	--	--	--	--
Projection	2 ⁷ / ₈ " (73mm)	2 ⁷ / ₈ " (73mm)	2 ⁷ / ₈ " (73mm)	2 ⁷ / ₈ " (73mm)
ANSI Function	08	09	--	02
Cylinder Type	1 ¹ / ₄ " Mortise	1 ¹ / ₄ " Mortise	--	--
Optional Trim (See pages 32 – 34)	x992L x994L	x992L-NL x994L-NL	x992L-BE x994L-BE	x992L-DT x994L-DT
#425 SNB optional-HMD Req. WD w/o SLM Pkg.	2	2	2	2

For optional trims and functions see pages 32-34

VON DUPRIN® 9827/9927 Surface Mounted Vertical Rod Device



9827/9927 surface mounted vertical rod device for all types of single or double doors, UL listed for Panic Exit Hardware. Devices are ANSI A156.3 – 2001 Grade 1. Covers stock hollow metal doors with 86 or 161 cutouts. The 9827 device has a smooth mechanism case and the 9927 device has a grooved case. The surface vertical rod device is non-handed except when the following device options are used: SD (Special Dogging), or SS (Signal Switch). See Opposite page for available outside trim and functions.

The 9827/9927 devices are available in the following finishes: US3, US4, US10, US26, US26D, US28, 313AN, 315AN and US32D for the 9827 device only. See page 52 for component finishes and the inside cover for finish chips.

Vertical rod and latch guards are available to protect the bottom rod of the exit device from damage by impacts of carts or gurneys passing through doors. Refer to page 49

Specifications

Device Functions	Device ships EO/DT/NL. Field selectable. For TPK, or L remove NL drive screw from device		
Device Lengths	3'	2'4" to 3' (711mm to 914 mm)	Door Size
	4'	2'10" to 4' (864 mm to 1219 mm)	Door Size
Strikes	Top - 299 – Dull Black, Bottom – 248L4 & 304L - Unfinished Optional Strikes – see page 39		
Dogging Feature	Hex key dogging standard		
Dogging Options	CD	Cylinder Dogging	see page 48
	SD	Special Center Case Dogging	see page 48
	LD	Less Dogging	see page 48
Electric Options	LX	Latchbolt Monitor Switch	see page 42
	RX	Pushpad Monitor Switch	see page 42
	RX2	Double Pushpad Monitor Switch	see page 42
	EL	Electric Latch Retraction	see page 43
	SS	Signal Switch	see page 43
	CX	Chexit Delayed Exit	see page 45
	ALK	Alarm Exit Kit	see page 42
Miscellaneous Options	PN	Pneumatic Latch Retraction	see page 48
	LBR	Less Bottom Rod	see page 49
	GBK	Glass Bead Kit	see page 49
	PL	Pullman Latch	see page 49
Fasteners & Sex Bolts (SNB)	Includes 1 3/4" (19mm) – 2 1/4" (57mm) Wood & Metal Doors SNB furnished for top & bottom latches Optional SNB available for device, see next page for quantities		
Latch Bolt	Deadlocking Anti-friction Top & Bottom Bolt, 5/8" (16mm) throw		
Device Centerline from Finished Floor	39 5/8" (1006 mm)		
Door Undercut	1/4" (7mm)		
Center Case Dimensions	8" x 2 3/4" x 2 3/8" (203mm x 70mm x 60mm)		
Mechanism Case Dimensions	2 1/4" x 2 1/4" (57mm x 57mm)		
Top & Bottom Latch Case	4 1/2" x 2 1/8" x 1 1/2" (114mm x 54mm x 38mm)		
Vertical Rods	1/2" square tubing, standard rods accommodate 7' (2134mm) door Top rod length is 34 15/16" (887mm) Bottom rod length is 31 1/4" (794mm) Extension rods available, 1' (205mm) or 3' (914mm) for doors over 7' One piece top rod available for 8' (2438mm) – 10' (3048mm) door		
Projection	Pushbar Neutral – 3 13/16" (97 mm) Pushbar Depressed – 3 1/16" (78 mm)		

See page 53 for How to Order specification

VON DUPRIN® 9827/9927 Surface Mounted Vertical Rod Device Standard Trim

	Exit only	Dummy Trim Pull when Dogged	Night Latch Key Retracts Latchbolt	Night Latch Key Retracts Latchbolt Optional Pull Required	Thumbturn Key Locks & Unlocks (Use with DT Trim)	Thumbturn Blank Escutcheon Always Operable (No Cylinder) (Use with DT Trim)
Product Description	9827EO 9927EO	9827DT 9927DT	9827NL 9927NL	9827NL-OP 9927NL-OP	9827TL 9927TL	9827TL-BE 9927TL-BE
Trim Description	---	990DT	990NL-R/V	110NL-MD 110NL-WD	374T x 990DT	374T-BE x 990DT
Escutcheon Plate Size	---	3" x 14 ³ / ₁₆ " x ³ / ₃₂ " (76x360x2mm)	3" x 14 ³ / ₁₆ " x ³ / ₃₂ " (76x360x2mm)	---	2 ⁹ / ₁₆ " x 5 ¹ / ₂ " x 2 ⁵ / ₈ " (65x140x67mm)	2 ³ / ₄ " x 10 ³ / ₄ " x ²⁷ / ₃₂ " (70x273x21mm)
Pull Center to Center	---	5 ¹ / ₂ " (140mm)	5 ¹ / ₂ " (140mm)	---	---	---
Projection	---	2" (51mm)	2" (51mm)	---	3 ¹ / ₄ " (83mm)	3 ¹ / ₄ " (83mm)
ANSI Function	01	02	03	03	11	---
Cylinder Type	---	---	Rim	Rim	1 ¹ / ₄ " Mortise	---
Optional Trim (See pages 32 – 34)	x990EO x992EO x994EO x996EO	x991K-DT x992L-DT x994L-DT x996L-DT x696DT x697DT	x991K-NL x992L-NL x994L-NL x996L-NL x696NL x697NL			
Optional #425 Sex Bolt Quantity for Device	6	2	2	6	2	2

	Lever Key Locks & Unlocks	Lever – Night Latch Key Retracts Latchbolt	Lever – Blank Escutcheon Always operable (No Cylinder)	Lever Dummy Trim Pull when Dogged
Product Description	9827L 9927L	9827L-NL 9927L-NL	9827L-BE 9927L-BE	9827L-DT 9927L-DT
Trim Description	996L-R/V	996L-NL-R/V	996L-BE-R/V	996L-DT-RV
Escutcheon Plate Size	2 ³ / ₄ " x 10 ³ / ₄ " x ²⁷ / ₃₂ " (70x273x21mm)	2 ³ / ₄ " x 10 ³ / ₄ " x ²⁷ / ₃₂ " (70x273x21mm)	2 ³ / ₄ " x 10 ³ / ₄ " x ²⁷ / ₃₂ " (70x273x21mm)	2 ³ / ₄ " x 10 ³ / ₄ " x ²⁷ / ₃₂ " (70x273x21mm)
Pull Center to Center	---	---	---	---
Projection	2 ⁷ / ₈ " (73mm)	2 ⁷ / ₈ " (73mm)	2 ⁷ / ₈ " (73mm)	2 ⁷ / ₈ " (73mm)
ANSI Function	08	09	---	02
Cylinder Type	Rim	Rim	---	---
Optional Trim (See pages 32 – 34)	x992L x994L	x992L-NL x994L-NL	x992L-BE x994L-BE	x992L-DT x994L-DT
Optional #425 Sex Bolt Quantity for Device	2	2	2	2

For optional trims and functions see pages 32-34

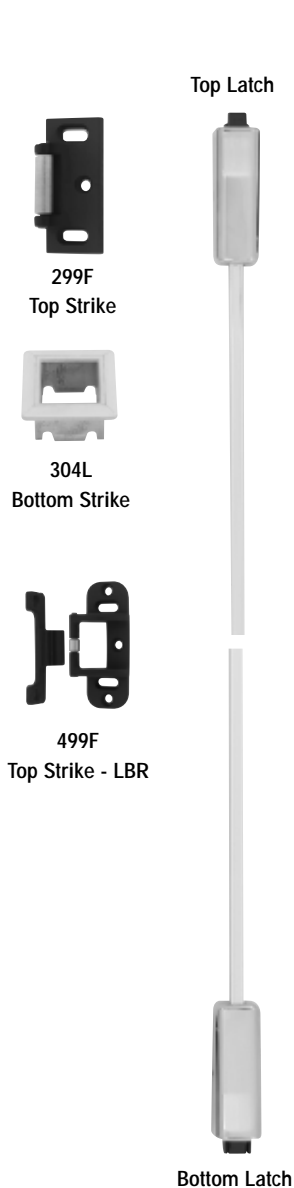

9827-F/9927-F fire exit surface mounted vertical rod device pairs of doors up to 8' x 10' (2438mm x 3048mm), UL listed for Fire Exit Hardware. See page 41 for detailed information on UL listed fire exit hardware label and door opening size information. Devices are ANSI A156.3 – 2001 Grade 1. The 9827-F device has a smooth mechanism case and the 9927-F device has a grooved case. The surface vertical rod device is non-handed except when the following device options are used: SS (Signal Switch). See Opposite page for available outside trim and device functions.

The 9827-F/9927-F devices are available in the following finishes: US3, US4, US10, US26, US26D, US28, 313AN, 315AN and US32D for the 9827-F device only. See page 52 for component finishes and the inside cover for finish chips.

Vertical rod and latch guards are available to protect the bottom rod of the exit device from damage by impacts of carts or gurneys passing through doors. Rod and latch guards can be used on hollow metal or tin clad composite fire doors. Refer to page 49

Specifications

Device Functions	Device ships EO/DT/NL. Field selectable. For TP,K, or L remove NL drive screw from device	
Device Lengths	3' 2'4" to 3' (711mm to 914 mm) Door Size	4' 2'10" to 4' (864 mm to 1219 mm) Door Size
Strikes	Top – 299F (499F LBR) – Dull Black, Bottom – 304L - Unfinished Optional Strikes – see page 39	
Dogging Feature	No Mechanical Dogging, EL option available	
Electric Options	LX Latchbolt Monitor Switch	see page 42
	RX Pushpad Monitor Switch	see page 42
	RX2 Double Pushpad Monitor Switch	see page 42
	EL Electric Latch Retraction	see page 43
	SS Signal Switch	see page 43
	CX Chexit Delayed Exit	see page 45
	ALK Alarm Exit Kit	see page 42
Miscellaneous Options	PN Pneumatic Latch Retraction	see page 48
	LBR Less Bottom Rod	see page 49
	GBK Glass Bead Kit	see page 49
Fasteners & Sex Bolts (SNB)	Includes 1 3/4" (19mm) – 2 1/4" (57mm) Wood & Metal Doors SNB furnished for top & bottom latches Optional SNB available for device, see next page for quantities Optional SLM Blocking Pkg for wood doors with SLM blocking SNB required for wood doors, unless SLM Blocking Pkg specified	
Latch Bolt	Deadlocking Anti-friction Top & Bottom Bolt, 5/8" (16mm) throw	
Device Centerline from Finished Floor	39 5/8" (1006 mm)	
Door Undercut	1/4" (7mm)	
Center Case Dimensions	8" x 2 3/4" x 2 3/8" (203mm x 70mm x 60mm)	
Mechanism Case Dimensions	2 1/4" x 2 1/4" (57mm x 57mm)	
Top & Bottom Latch Case	4 1/2" x 2 1/8" x 1 1/2" (114mm x 54mm x 38mm)	
Vertical Rods	1/2" square tubing, standard rods accommodate 7' (2134mm) door Top rod length is 34 15/16" (887mm) Bottom rod length is 31 1/4" (794mm) Extension rods available, 1' (205mm) or 3' (914mm) for doors over 7' One piece top rod available for 8' (2438mm) – 10' (3048mm) door	
Projection	Pushbar Neutral – 3 13/16" (97 mm)	Pushbar Depressed – 3 1/16" (78 mm)

See page 53 for How to Order specification

VON DUPRIN® 9827-F/9927-F Surface Mounted Vertical Rod Fire Device Standard Trim

	Exit only	Dummy Trim Pull when Dogged (Not recommended for Fire Device)	Night Latch Key Retracts Latchbolt	Night Latch Key Retracts Latchbolt Optional Pull Required	Thumbturn Key Locks & Unlocks (Use with DT Trim)	Thumbturn Blank Escutcheon Always Operable (No Cylinder) (Use with DT Trim)
Product Description	9827EO-F 9927EO-F	---	9827NL-F 9927NL-F	9827NL-OP-F 9927NL-OP-F	9827TL-F 9927TL-F	9827TL-BE-F 9927TL-BE-F
Trim Description	---	990DT	990NL-R/V	110NL-MD 110NL-WD	374T x 990DT	374T-BE x 990DT
Escutcheon Plate Size	---	3" x 14 ⁹ / ₁₆ " x ³ / ₃₂ " (76x360x2mm)	3" x 14 ⁹ / ₁₆ " x ³ / ₃₂ " (76x360x2mm)	---	2 ³ / ₄ " x 10 ³ / ₄ " x ²⁷ / ₃₂ " (70x273x21mm)	2 ³ / ₄ " x 10 ³ / ₄ " x ²⁷ / ₃₂ " (70x273x21mm)
Pull Center to Center	---	5 ¹ / ₂ " (140mm)	5 ¹ / ₂ " (140mm)	---	---	---
Projection	---	2" (51mm)	2" (51mm)	---	3 ¹ / ₄ " (83mm)	3 ¹ / ₄ " (83mm)
ANSI Function	01	02	03	03	11	---
Cylinder Type	---	---	Rim	Rim	1 ¹ / ₄ " Mortise	---
Optional Trim (See pages 32 – 34)	x990EO x992EO x994EO x996EO	x991K-DT x992L-DT x994L-DT x996L-DT x696DT x697DT	x991K-NL x992L-NL x994L-NL x996L-NL x696NL x697NL			
#425 SNB optional-HMD Req. WD w/o SLM Pkg.	6	2	2	6	2	2

	Lever Key Locks & Unlocks	Lever – Night Latch Key Retracts Latchbolt	Lever – Blank Escutcheon Always operable (No Cylinder)	Lever Dummy Trim Pull when Dogged (Not recommended for Fire Device)
Product Description	9827L-F 9927L-F	9827L-NL-F 9927L-NL-F	9827L-BE-F 9927L-BE-F	---
Trim Description	996L-R/V	996L-NL-R/V	996L-BE-R/V	996L-DT-RV
Escutcheon Plate Size	2 ³ / ₄ " x 10 ³ / ₄ " x ²⁷ / ₃₂ " (70x273x21mm)	2 ³ / ₄ " x 10 ³ / ₄ " x ²⁷ / ₃₂ " (70x273x21mm)	2 ³ / ₄ " x 10 ³ / ₄ " x ²⁷ / ₃₂ " (70x273x21mm)	2 ³ / ₄ " x 10 ³ / ₄ " x ²⁷ / ₃₂ " (70x273x21mm)
Pull Center to Center	---	---	---	---
Projection	2 ⁷ / ₈ " (73mm)	2 ⁷ / ₈ " (73mm)	2 ⁷ / ₈ " (73mm)	2 ⁷ / ₈ " (73mm)
ANSI Function	08	09	---	02
Cylinder Type	Rim	Rim	---	---
Optional Trim (See pages 32 – 34)	x992L x994L	x992L-NL x994L-NL	x992L-BE x994L-BE	x992L-DT x994L-DT
#425 SNB optional-HMD Req. WD w/o SLM Pkg.	2	2	2	2

For optional trims and functions see pages 32-34

VON DUPRIN® 9857/9957 Three-Point Latching Device



9857/9957 three-point latching device for all types of single or double doors, UL listed for Panic Exit Hardware. Devices are ANSI A156.3 – 2001 Grade 1. Covers stock hollow metal doors with 86 or 161 cutouts. The 9857 device has a smooth mechanism case and the 9957 device has a grooved case. The three-point latching device is non-handed except when the following device options are used: SD (Special Dogging), or SS (Signal Switch). See Opposite page for available outside trim and functions.

The 9857/9957 devices are available in the following finishes: US3, US4, US10, US26, US26D, US28, 313AN, 315AN and US32D for the 9857 device only. See page 52 for component finishes and the inside cover for finish chips.

Vertical rod and latch guards are available to protect the bottom rod of the exit device from damage by impacts of carts or gurneys passing through doors. Refer to Page 49.

Specifications

Device Functions	Device ships EO/DT/NL. Field selectable. For TPK, or L remove NL drive screw from device	
Device Lengths	3' 2'4" to 3' (711mm to 914 mm) Door Size	
	4' 2'10" to 4' (864 mm to 1219 mm) Door Size	
Strikes	Top & Middle-299-Dull Black, Bottom-248L4 & 304L-Unfinished Optional Strikes – see page 39	
Dogging Feature	Hex key dogging standard	
Dogging Options	CD Cylinder Dogging	see page 48
	SD Special Center Case Dogging	see page 48
	LD Less Dogging	see page 48
Electric Options	LX Latchbolt Monitor Switch	see page 42
	RX Pushpad Monitor Switch	see page 42
	RX2 Double Pushpad Monitor Switch	see page 42
	EL Electric Latch Retraction	see page 43
	SS Signal Switch	see page 43
	CX Chexit Delayed Exit	see page 45
	ALK Alarm Exit Kit	see page 42
Miscellaneous Options	PN Pneumatic Latch Retraction	see page 48
	LBR Less Bottom Rod	see page 49
	GBK Glass Bead Kit	see page 49
Fasteners & Sex Bolts (SNB)	Includes 1 ¾" (19mm) – 2 ¼" (57mm) Wood & Metal Doors SNB furnished for top & bottom latches Optional SNB available for device, see next page for quantities	
Latch Bolt	Deadlocking Anti-friction Top & Bottom Bolt, 5/8" (16mm) throw Deadlocking Rim Bolt, ¾" (19mm) throw	
Device Centerline from Finished Floor	39 13/16" (1011 mm)	
Door Undercut	¼" (7mm)	
Center Case Dimensions	8" x 2 ¾" x 2 ¾" (203mm x 70mm x 60mm)	
Mechanism Case Dimensions	2 ¼" x 2 ¼" (57mm x 57mm)	
Top & Bottom Latch Case	4 ½" x 2 ⅛" x 1 ½" (114mm x 54mm x 38mm)	
Vertical Rods	½" square tubing, standard rods accommodate 7' (2134mm) door Top rod length is 34 15/16" (887mm) Bottom rod length is 31 ¼" (794mm) Extension rods available, 1' (205mm) or 3' (914mm) for doors over 7' One piece top rod available for 8' (2438mm) – 10' (3048mm) door	
Projection	Pushbar Neutral – 3 13/16" (97 mm) Pushbar Depressed – 3 1/16" (78 mm)	

See page 53 for How to Order specification

VON DUPRIN® 9857/9957 Three-Point Latching Device Standard Trim

	Exit only	Dummy Trim Pull when Dogged	Night Latch Key Retracts Latchbolt	Night Latch Key Retracts Latchbolt Optional Pull Required	Thumbturn Key Locks & Unlocks (Use with DT Trim)	Thumbturn Blank Escutcheon Always Operable (No Cylinder) (Use with DT Trim)
Product Description	9857EO 9957EO	9857DT 9957DT	9857NL 9957NL	9857NL-OP 9957NL-OP	9857TL 9957TL	9857TL-BE 9957TL-BE
Trim Description	—	990DT	990NL-R/V	110NL-MD 110NL-WD	374T x 990DT	374T-BE x 990DT
Escutcheon Plate Size	—	3" x 14 ⁹ / ₁₆ " x ³ / ₃₂ " (76x360x2mm)	3" x 14 ⁹ / ₁₆ " x ³ / ₃₂ " (76x360x2mm)	—	2 ³ / ₄ " x 10 ³ / ₄ " x ²⁷ / ₃₂ " (70x273x21mm)	2 ³ / ₄ " x 10 ³ / ₄ " x ²⁷ / ₃₂ " (70x273x21mm)
Pull Center to Center	—	5 ¹ / ₂ " (140mm)	5 ¹ / ₂ " (140mm)	—	—	—
Projection	—	2" (51mm)	2" (51mm)	—	3 ¹ / ₄ " (83mm)	3 ¹ / ₄ " (83mm)
ANSI Function	01	02	03	03	11	—
Cylinder Type	—	—	Rim	Rim	1 ¹ / ₄ " Mortise	—
Optional Trim (See pages 32 – 34)	x990EO x992EO x994EO x996EO	x991K-DT x992L-DT x994L-DT x996L-DT x696DT x697DT	x991K-NL x992L-NL x994L-NL x996L-NL x696NL x697NL			
Optional #425 Sex Bolt Quantity for Device	6	2	2	6	2	2

	Lever Key Locks & Unlocks	Lever – Night Latch Key Retracts Latchbolt	Lever – Blank Escutcheon Always operable (No Cylinder)	Lever Dummy Trim Pull when Dogged
Product Description	9857L 9957L	9857L-NL 9957L-NL	9857L-BE 9957L-BE	9857L-DT 9957L-DT
Trim Description	996L-R/V	996L-NL-R/V	996L-BE-R/V	996L-DT-RV
Escutcheon Plate Size	2 ³ / ₄ " x 10 ³ / ₄ " x ²⁷ / ₃₂ " (70x273x21mm)	2 ³ / ₄ " x 10 ³ / ₄ " x ²⁷ / ₃₂ " (70x273x21mm)	2 ³ / ₄ " x 10 ³ / ₄ " x ²⁷ / ₃₂ " (70x273x21mm)	2 ³ / ₄ " x 10 ³ / ₄ " x ²⁷ / ₃₂ " (70x273x21mm)
Pull Center to Center	—	—	—	—
Projection	2 ⁷ / ₈ " (73mm)	2 ⁷ / ₈ " (73mm)	2 ⁷ / ₈ " (73mm)	2 ⁷ / ₈ " (73mm)
ANSI Function	08	09	—	02
Cylinder Type	Rim	Rim	—	—
Optional Trim (See pages 32 – 34)	x992L x994L	x992L-NL x994L-NL	x992L-BE x994L-BE	x992L-DT x994L-DT
Optional #425 Sex Bolt Quantity for Device	2	2	2	2

For optional trims and functions see pages 32-34

VON DUPRIN® 9857-F/9957-F Three-Point Latching Fire Device

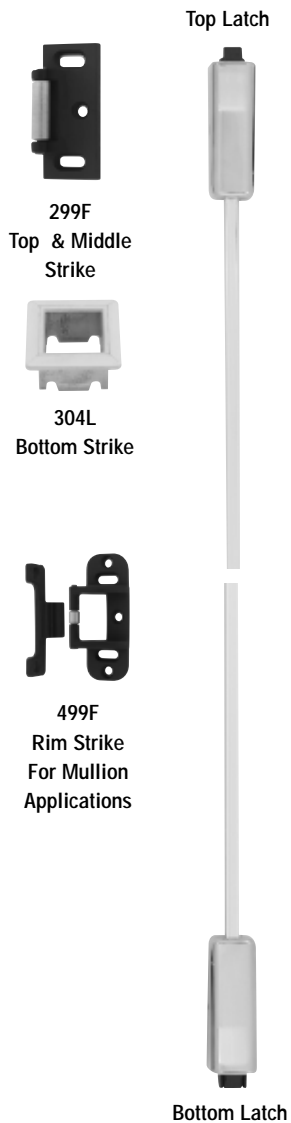

9857-F/9957-F fire exit three-point latching device for all types of single doors up to 4' x 8' (1219mm x 2438mm) or up to 8' x 8' (2438mm x 2438mm) double doors with 9954 or 9854 mullion, UL listed for Fire Exit Hardware. See page 41 for detailed information on UL listed fire exit hardware label and door opening size information. Devices are ANSI A156.3 – 2001 Grade 1. The 9857-F device has a smooth mechanism case and the 9957-F device has a grooved case. The three-point latch device is non-handed except when the following device option is used: SS (Signal Switch). See Opposite page for available outside trim and device functions.

The 9857-F/9957-F devices are available in the following finishes: US3, US4, US10, US26, US26D, US28, 313AN, 315AN and US32D for the 9827-F device only. See page 52 for component finishes and the inside cover for finish chips.

Vertical rod and latch guards are available to protect the bottom rod of the exit device from damage by impacts of carts or gurneys passing through doors. Refer to Page 49.

Specifications

Device Functions	Device ships EO/DT/NL. Field selectable. For TP,K,or L remove NL drive screw from device		
Device Lengths	3'	2'4" to 3'	(711mm to 914 mm) Door Size
	4'	2'10" to 4'	(864 mm to 1219 mm) Door Size
Strikes	Top & Middle-299F-Dull Black, Bottom-304L-Unfinished Optional Strikes – see page 39		
Dogging Feature	No Mechanical Dogging, EL option available		
Electric Options	LX	Latchbolt Monitor Switch	see page 42
	RX	Pushpad Monitor Switch	see page 42
	RX2	Double Pushpad Monitor Switch	see page 42
	EL	Electric Latch Retraction	see page 43
	SS	Signal Switch	see page 43
	CX	Chexit Delayed Exit	see page 45
	ALK	Alarm Exit Kit	see page 42
Miscellaneous Options	PN	Pneumatic Latch Retraction	see page 48
	GBK	Glass Bead Kit	see page 49
Fasteners & Sex Bolts (SNB)	Includes 1 3/4" (19mm) – 2 1/4" (57mm) Wood & Metal Doors SNB furnished for top & bottom latches Optional SNB available for device, see next page for quantities Optional SLM Blocking Pkg for wood doors with SLM blocking SNB required for wood doors, unless SLM Blocking Pkg specified		
Latch Bolt	Deadlocking Anti-friction Top & Bottom Bolt, 5/8" (16mm) throw Deadlocking Rim Bolt, 3/4" (19mm) throw		
Device Centerline from Finished Floor	39 13/16" (1011 mm)		
Door Undercut	1/4" (7mm)		
Center Case Dimensions	8" x 2 3/4" x 2 3/8" (203mm x 70mm x 60mm)		
Mechanism Case Dimensions	2 1/4" x 2 1/4" (57mm x 57mm)		
Top & Bottom Latch Case	4 1/2" x 2 1/8" x 1 1/2" (114mm x 54mm x 38mm)		
Vertical Rods	1/2" square tubing, standard rods accommodate 7' (2134mm) door Top rod length is 34 13/16" (887mm) Bottom rod length is 31 1/4" (794mm) Extension rods available, 1' (205mm) or 3' (914mm) for doors over 7' One piece top rod available for 8' (2438mm) – 10' (3048mm) door		
Projection	Pushbar Neutral – 3 13/16" (97 mm) Pushbar Depressed – 3 1/16" (78 mm)		

See page 53 for How to Order specification

VON DUPRIN® 9857-F/9957-F Three-Point Latching Fire Device Standard Trim

	Exit only	Dummy Trim Pull when Dogged (Not recommended for Fire Device)	Night Latch Key Retracts Latchbolt	Night Latch Key Retracts Latchbolt Optional Pull Required	Thumbturn Key Locks & Unlocks (Use with DT Trim)	Thumbturn Blank Escutcheon Always Operable (No Cylinder) (Use with DT Trim)
Product Description	9857EO-F 9957EO-F	---	9857NL-F 9957NL-F	9857NL-OP-F 9957NL-OP-F	9857TL-F 9957TL-F	9857TL-BE-F 9957TL-BE-F
Trim Description	---	990DT	990NL-R/V	110NL-MD 110NL-WD	374T x 990DT	374T-BE x 990DT
Escutcheon Plate Size	---	3" x 14 ³ / ₁₆ " x 3 ³ / ₃₂ " (76x360x2mm)	3" x 14 ³ / ₁₆ " x 3 ³ / ₃₂ " (76x360x2mm)	---	2 ³ / ₄ " x 10 ³ / ₄ " x 2 ⁷ / ₃₂ " (70x273x21mm)	2 ³ / ₄ " x 10 ³ / ₄ " x 2 ⁷ / ₃₂ " (70x273x21mm)
Pull Center to Center	---	5 ¹ / ₂ " (140mm)	5 ¹ / ₂ " (140mm)	---	---	---
Projection	---	2" (51mm)	2" (51mm)	---	3 ¹ / ₄ " (83mm)	3 ¹ / ₄ " (83mm)
ANSI Function	01	02	03	03	11	---
Cylinder Type	---	---	Rim	Rim	1 ¹ / ₄ " Mortise	---
Optional Trim (See pages 32 – 34)	x990EO x992EO x994EO x996EO	x991K-DT x992L-DT x994L-DT x996L-DT x696DT x697DT	x991K-NL x992L-NL x994L-NL x996L-NL x696NL x697NL			
#425 SNB optional-HMD Req. WD w/o SLM Pkg.	6	2	2	6	2	2
#425 SNB Req. w/ 499F	2	2	2	2	2	2

	Lever Key Locks & Unlocks	Lever – Night Latch Key Retracts Latchbolt	Lever – Blank Escutcheon Always operable (No Cylinder)	Lever Dummy Trim Pull when Dogged (Not recommended for Fire Device)
Product Description	9857L-F 9957L-F	9857L-NL-F 9957L-NL-F	9857L-BE-F 9957L-BE-F	---
Trim Description	996L-R/V	996L-NL-R/V	996L-BE-R/V	996L-DT-RV
Escutcheon Plate Size	2 ³ / ₄ " x 10 ³ / ₄ " x 2 ⁷ / ₃₂ " (70x273x21mm)	2 ³ / ₄ " x 10 ³ / ₄ " x 2 ⁷ / ₃₂ " (70x273x21mm)	2 ³ / ₄ " x 10 ³ / ₄ " x 2 ⁷ / ₃₂ " (70x273x21mm)	2 ³ / ₄ " x 10 ³ / ₄ " x 2 ⁷ / ₃₂ " (70x273x21mm)
Pull Center to Center	---	---	---	---
Projection	2 ⁷ / ₈ " (73mm)	2 ⁷ / ₈ " (73mm)	2 ⁷ / ₈ " (73mm)	2 ⁷ / ₈ " (73mm)
ANSI Function	08	09	---	02
Cylinder Type	Rim	Rim	---	---
Optional Trim (See pages 32 – 34)	x992L x994L	x992L-NL x994L-NL	x992L-BE x994L-BE	x992L-DT x994L-DT
#425 SNB optional-HMD Req. WD w/o SLM Pkg.	2	2	2	2
#425 SNB Req. w/ 499F	2	2	2	2

For optional trims and functions see pages 32-34

VON DUPRIN® 9847/9947 Concealed Vertical Rod Device

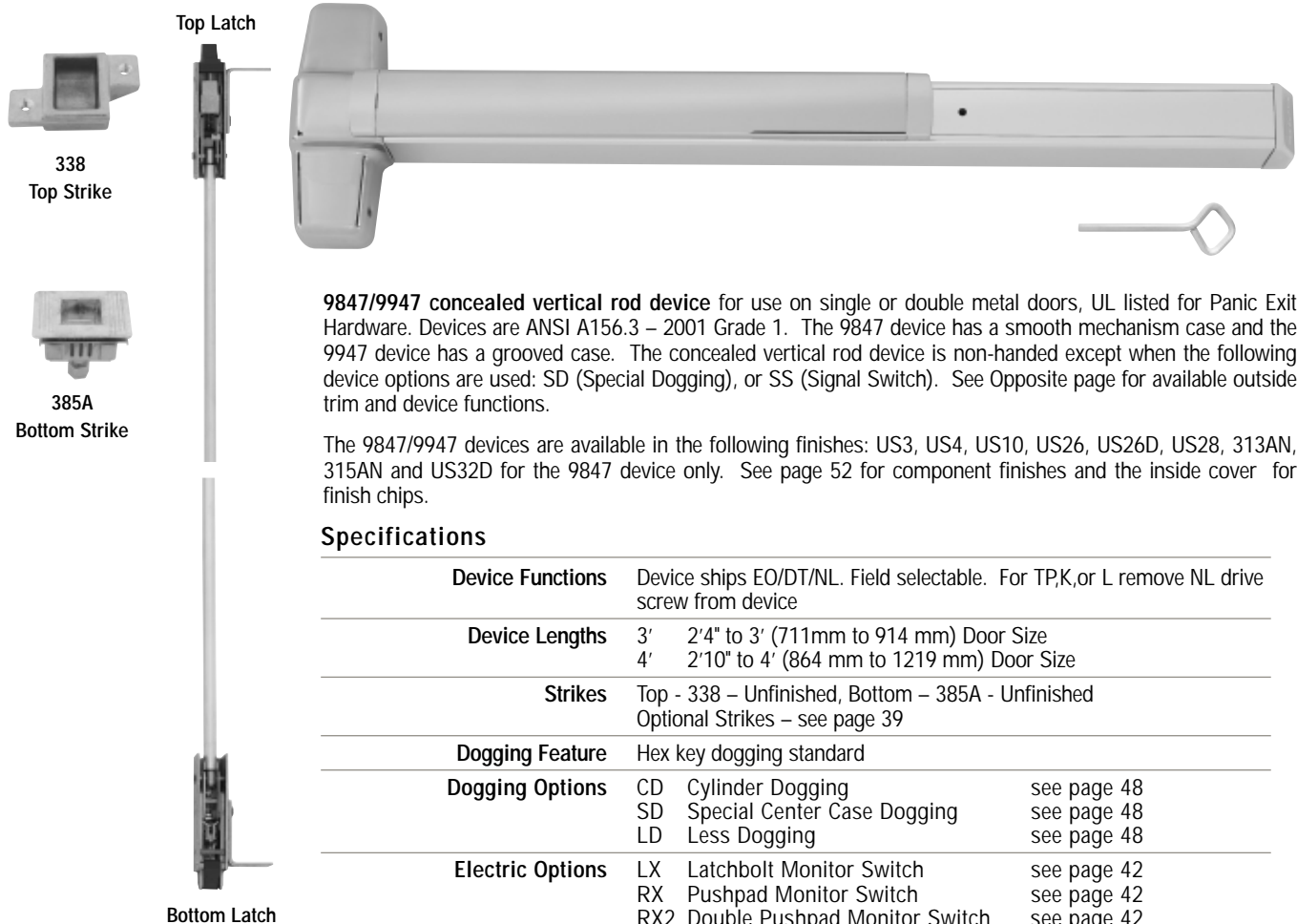

9847/9947 concealed vertical rod device for use on single or double metal doors, UL listed for Panic Exit Hardware. Devices are ANSI A156.3 – 2001 Grade 1. The 9847 device has a smooth mechanism case and the 9947 device has a grooved case. The concealed vertical rod device is non-handed except when the following device options are used: SD (Special Dogging), or SS (Signal Switch). See Opposite page for available outside trim and device functions.

The 9847/9947 devices are available in the following finishes: US3, US4, US10, US26, US26D, US28, 313AN, 315AN and US32D for the 9847 device only. See page 52 for component finishes and the inside cover for finish chips.

Specifications

Device Functions	Device ships EO/DT/NL. Field selectable. For TPK, or L remove NL drive screw from device	
Device Lengths	3' 2'4" to 3' (711mm to 914 mm) Door Size 4' 2'10" to 4' (864 mm to 1219 mm) Door Size	
Strikes	Top - 338 – Unfinished, Bottom – 385A - Unfinished Optional Strikes – see page 39	
Dogging Feature	Hex key dogging standard	
Dogging Options	CD Cylinder Dogging	see page 48
	SD Special Center Case Dogging	see page 48
	LD Less Dogging	see page 48
Electric Options	LX Latchbolt Monitor Switch	see page 42
	RX Pushpad Monitor Switch	see page 42
	RX2 Double Pushpad Monitor Switch	see page 42
	EL Electric Latch Retraction	see page 43
	SS Signal Switch	see page 43
	CX Chexit Delayed Exit	see page 45
	ALK Alarm Exit Kit	see page 42
Miscellaneous Options	PN Pneumatic Latch Retraction	see page 48
	LBR Less Bottom Rod	see page 49
	GBK Glass Bead Kit	see page 49
	PL Pullman Latch	see page 49
Fasteners & Sex Bolts (SNB)	Includes 1 3/4" (19mm) – 2 1/4" (57mm) Wood & Metal Doors Optional SNB available for device, see next page for quantities	
Latch Bolt	Deadlocking Top & Bottom Bolt, 5/8" (16mm) throw	
Device Centerline from Finished Floor	39 5/8" (1006 mm) Standard, Adjustable from 35 5/8" (905mm) to 49 5/8" (1260mm)	
Door Undercut	1/4" (7mm) maximum	
Center Case Dimensions	8" x 2 3/4" x 2 3/8" (203mm x 70mm x 60mm)	
Mechanism Case Dimensions	2 1/4" x 2 1/4" (57mm x 57mm)	
Top & Bottom Latch Case	4 1/2" x 2 1/8" x 1 1/2" (114mm x 54mm x 38mm)	
Vertical Rods	Round 2 piece adjustable rods Top rod adjustable from 6'8" (2027mm) to 8'4" (2533mm) Bottom rod adjustable 35 5/8" (905 mm) to 49 5/8" (1260 mm) Extension rod kits available for doors over 8'4" (2533mm)	
Projection	Pushbar Neutral – 3 13/16" (97 mm) Pushbar Depressed – 3 1/16" (78 mm)	

See page 53 for How to Order specification

VON DUPRIN® 9847/9947 Concealed Vertical Rod Device Standard Trim

	Exit only	Dummy Trim Pull when Dogged	Night Latch Key Retracts Latchbolt	Night Latch Key Retracts Latchbolt Optional Pull Required	Thumbturn Key Locks & Unlocks (Use with DT Trim)	Thumbturn Blank Escutcheon Always Operable (No Cylinder) (Use with DT Trim)
Product Description	9847EO 9947EO	9847DT 9947DT	9847NL 9947NL	9847NL-OP 9947NL-OP	9847TL 9947TL	9847TL-BE 9947TL-BE
Trim Description	—	990DT	990NL-R/V	110NL-MD	374T x 990DT	374T-BE x 990DT
Escutcheon Plate Size	—	3" x 14 ⁹ / ₁₆ " x ³ / ₃₂ " (76x360x2mm)	3" x 14 ⁹ / ₁₆ " x ³ / ₃₂ " (76x360x2mm)	—	2 ³ / ₄ " x 10 ³ / ₄ " x ²⁷ / ₃₂ " (70x273x21mm)	2 ³ / ₄ " x 10 ³ / ₄ " x ²⁷ / ₃₂ " (70x273x21mm)
Pull Center to Center	—	5 ¹ / ₂ " (140mm)	5 ¹ / ₂ " (140mm)	—	—	—
Projection	—	2" (51mm)	2" (51mm)	—	3 ¹ / ₄ " (83mm)	3 ¹ / ₄ " (83mm)
ANSI Function	01	02	03	03	11	—
Cylinder Type	—	—	Rim	Rim	1 ¹ / ₄ " Mortise	—
Optional Trim (See pages 32 – 34)	x990EO x992EO x994EO x996EO	x991K-DT x992L-DT x994L-DT x996L-DT x696DT x697DT	x991K-NL x992L-NL x994L-NL x996L-NL x696NL x697NL			
Optional #425 Sex Bolt Quantity for Device	6	2	2	6	2	2

	Lever Key Locks & Unlocks	Lever – Night Latch Key Retracts Latchbolt	Lever – Blank Escutcheon Always operable (No Cylinder)	Lever Dummy Trim Pull when Dogged
Product Description	9847L 9947L	9847L-NL 9947L-NL	9847L-BE 9947L-BE	9847L-DT 9947L-DT
Trim Description	996L-CV	996L-NL-CV	996L-BE-CV	996L-DT-CV
Escutcheon Plate Size	2 ³ / ₄ " x 10 ³ / ₄ " x ²⁷ / ₃₂ " (70x273x21mm)	2 ³ / ₄ " x 10 ³ / ₄ " x ²⁷ / ₃₂ " (70x273x21mm)	2 ³ / ₄ " x 10 ³ / ₄ " x ²⁷ / ₃₂ " (70x273x21mm)	2 ³ / ₄ " x 10 ³ / ₄ " x ²⁷ / ₃₂ " (70x273x21mm)
Pull Center to Center	—	—	—	—
Projection	2 ⁷ / ₈ " (73mm)	2 ⁷ / ₈ " (73mm)	2 ⁷ / ₈ " (73mm)	2 ⁷ / ₈ " (73mm)
ANSI Function	08	09	—	02
Cylinder Type	Rim	Rim	—	—
Optional Trim (See pages 32 – 34)	x992L x994L	x992L-NL x994L-NL	x992L-BE x994L-BE	x992L-DT x994L-DT
Optional #425 Sex Bolt Quantity for Device	2	2	2	2

For optional trims and functions see pages 32-34

VON DUPRIN® 9847-F/9947-F Concealed Vertical Rod Fire Device

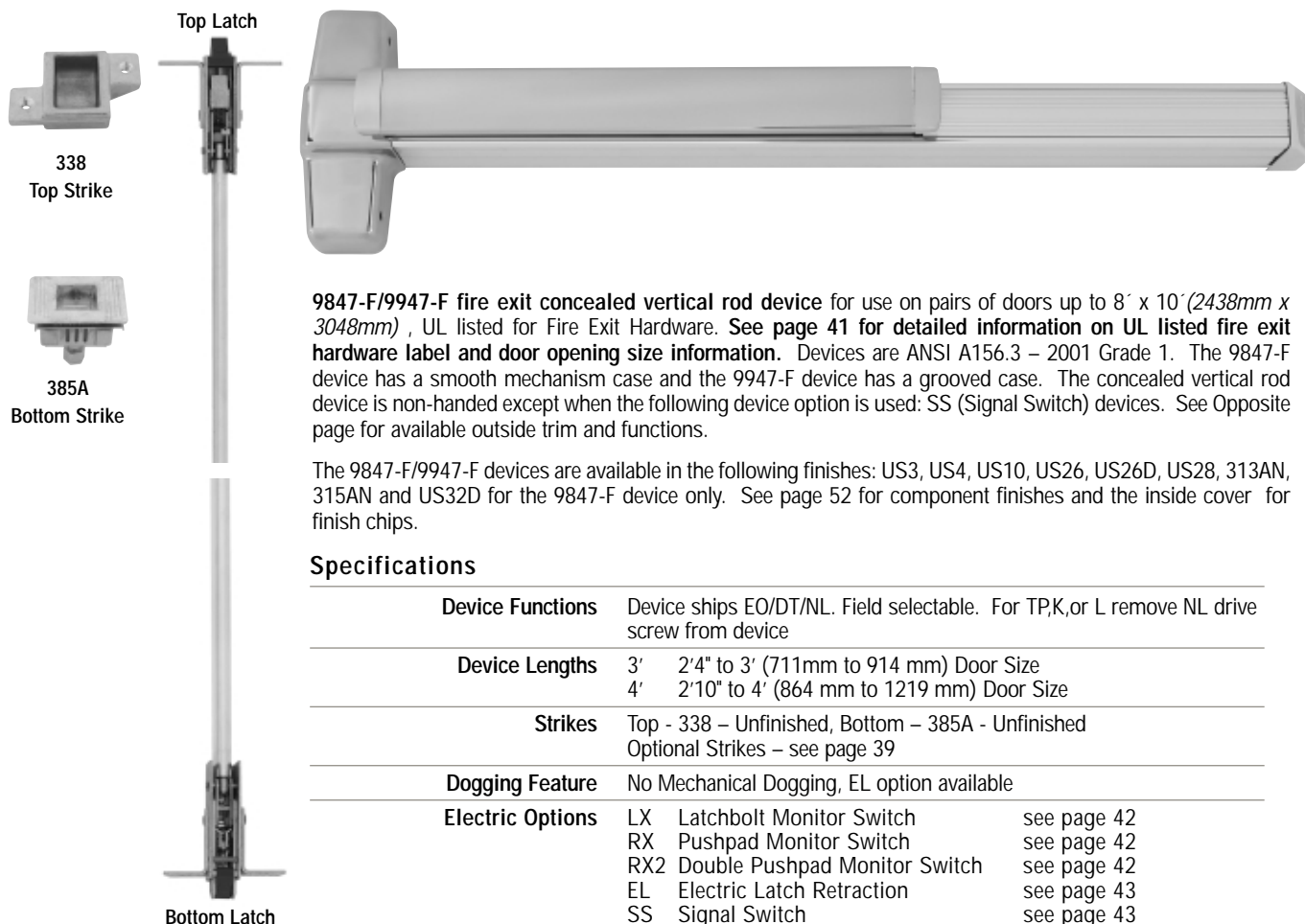

9847-F/9947-F fire exit concealed vertical rod device for use on pairs of doors up to 8' x 10' (2438mm x 3048mm), UL listed for Fire Exit Hardware. See page 41 for detailed information on UL listed fire exit hardware label and door opening size information. Devices are ANSI A156.3 – 2001 Grade 1. The 9847-F device has a smooth mechanism case and the 9947-F device has a grooved case. The concealed vertical rod device is non-handed except when the following device option is used: SS (Signal Switch) devices. See Opposite page for available outside trim and functions.

The 9847-F/9947-F devices are available in the following finishes: US3, US4, US10, US26, US26D, US28, 313AN, 315AN and US32D for the 9847-F device only. See page 52 for component finishes and the inside cover for finish chips.

Specifications

Device Functions	Device ships EO/DT/NL. Field selectable. For TP,K,or L remove NL drive screw from device	
Device Lengths	3' 2'4" to 3' (711mm to 914 mm) Door Size 4' 2'10" to 4' (864 mm to 1219 mm) Door Size	
Strikes	Top - 338 – Unfinished, Bottom – 385A - Unfinished Optional Strikes – see page 39	
Dogging Feature	No Mechanical Dogging, EL option available	
Electric Options	LX Latchbolt Monitor Switch	see page 42
	RX Pushpad Monitor Switch	see page 42
	RX2 Double Pushpad Monitor Switch	see page 42
	EL Electric Latch Retraction	see page 43
	SS Signal Switch	see page 43
	CX Chexit Delayed Exit	see page 45
	ALK Alarm Exit Kit	see page 42
Miscellaneous Options	PN Pneumatic Latch Retraction	see page 48
	LBR Less Bottom Rod	see page 49
	GBK Glass Bead Kit	see page 49
Fasteners & Sex Bolts (SNB)	Includes 1 3/4" (19mm) – 2 1/4" (57mm) Wood & Metal Doors Optional SNB available for device, see next page for quantities Optional SLM Blocking Pkg for wood doors with SLM blocking SNB required for wood doors, unless SLM Blocking Pkg specified	
Latch Bolt	Deadlocking Anti-friction Top & Bottom Bolt, 5/8" (16mm) throw	
Device Centerline from Finished Floor	39 5/8" (1006 mm) Standard, Adjustable from 35 5/8" (905mm) to 49 5/8" (1260mm)	
Door Undercut	1/4" (7mm) maximum	
Center Case Dimensions	8" x 2 3/4" x 2 3/8" (203mm x 70mm x 60mm)	
Mechanism Case Dimensions	2 1/4" x 2 1/4" (57mm x 57mm)	
Top & Bottom Latch Case	4 1/2" x 2 1/8" x 1 1/2" (114mm x 54mm x 38mm)	
Vertical Rods	Round 2 piece adjustable rods Top rod adjustable from 6'8" (2027mm) to 8'4"(2533mm) Bottom rod adjustable 35 5/8" (905 mm) to 49 5/8" (1260 mm) Extension rod kits available for doors over 8'4" (2533mm)	
Projection	Pushbar Neutral – 3 13/16" (97 mm) Pushbar Depressed – 3 1/16" (78 mm)	

See page 53 for How to Order specification

	Exit only	Dummy Trim Pull when Dogged (Not recommended for Fire Device)	Night Latch Key Retracts Latchbolt	Night Latch Key Retracts Latchbolt Optional Pull Required	Thumbturn Key Locks & Unlocks (Use with DT Trim)	Thumbturn Blank Escutcheon Always Operable (No Cylinder) (Use with DT Trim)
Product Description	9847EO-F 9947EO-F	---	9847NL-F 9947NL-F	9847NL-OP-F 9947NL-OP-F	9847TL-F 9947TL-F	9847TL-BE-F 9947TL-BE-F
Trim Description	---	990DT	990NL-R/V	110NL-MD	374T x 990DT	374T-BE x 990DT
Escutcheon Plate Size	---	3" x 14 ⁹ / ₁₆ " x ³ / ₃₂ " (76x360x2mm)	3" x 14 ⁹ / ₁₆ " x ³ / ₃₂ " (76x360x2mm)	---	2 ³ / ₄ " x 10 ³ / ₄ " x ²⁷ / ₃₂ " (70x273x21mm)	2 ³ / ₄ " x 10 ³ / ₄ " x ²⁷ / ₃₂ " (70x273x21mm)
Pull Center to Center	---	5 ¹ / ₂ " (140mm)	5 ¹ / ₂ " (140mm)	---	---	---
Projection	---	2" (51mm)	2" (51mm)	---	3 ¹ / ₄ " (83mm)	3 ¹ / ₄ " (83mm)
ANSI Function	01	02	03	03	11	---
Cylinder Type	---	---	Rim	Rim	1 ¹ / ₄ " Mortise	---
Optional Trim (See pages 32 – 34)	x990EO x992EO x994EO x996EO	x991K-DT x992L-DT x994L-DT x996L-DT x696DT x697DT	x991K-NL x992L-NL x994L-NL x996L-NL x696NL x697NL			
#425 SNB optional-HMD Req. WD w/o SLM Pkg.	6	2	2	6	2	2

	Lever Key Locks & Unlocks	Lever – Night Latch Key Retracts Latchbolt	Lever – Blank Escutcheon Always operable (No Cylinder)	Lever Dummy Trim Pull when Dogged (Not recommended for Fire Device)
Product Description	9847L-F 9947L-F	9847L-NL-F 9947L-NL-F	9847L-BE-F 9947L-BE-F	---
Trim Description	996L-CV	996L-NL-CV	996L-BE-CV	996L-DT-CV
Escutcheon Plate Size	2 ³ / ₄ " x 10 ³ / ₄ " x ²⁷ / ₃₂ " (70x273x21mm)	2 ³ / ₄ " x 10 ³ / ₄ " x ²⁷ / ₃₂ " (70x273x21mm)	2 ³ / ₄ " x 10 ³ / ₄ " x ²⁷ / ₃₂ " (70x273x21mm)	2 ³ / ₄ " x 10 ³ / ₄ " x ²⁷ / ₃₂ " (70x273x21mm)
Pull Center to Center	---	---	---	---
Projection	2 ⁷ / ₈ " (73mm)	2 ⁷ / ₈ " (73mm)	2 ⁷ / ₈ " (73mm)	2 ⁷ / ₈ " (73mm)
ANSI Function	08	09	---	02
Cylinder Type	Rim	Rim	---	---
Optional Trim (See pages 32 – 34)	x992L x994L	x992L-NL x994L-NL	x992L-BE x994L-BE	x992L-DT x994L-DT
#425 SNB optional-HMD Req. WD w/o SLM Pkg.	2	2	2	2

For optional trims and functions see pages 32-34

VON DUPRIN® 9848/9948 Concealed Vertical Rod Device



9848/9948 Concealed vertical rod device for use on single or double metal doors, UL listed for Panic Exit Hardware. Covers stock hollow metal doors with 86 or 161 cutouts. Devices are ANSI A156.3 – 2001 Grade 1. The 9848 device has a smooth mechanism case and the 9948 device has a grooved case. The concealed vertical rod device is non-handed except when the following device options are used: SD (Special Dogging), or SS (Signal Switch). See Opposite page for available outside trim and functions.

The 9848/9948 devices are available in the following finishes: US3, US4, US10, US26, US26D, US28, 313AN, 315AN and US32D for the 9848 device only. See page 52 for component finishes and the inside cover for finish chips.

Specifications

Device Functions	Device ships EO/DT/NL. Field selectable. For TP,K,or L remove NL drive screw from device	
Device Lengths	3' 2'4" to 3' (711mm to 914 mm) Door Size	
	4' 2'10" to 4' (864 mm to 1219 mm) Door Size	
Strikes	Top - 338 – Unfinished, Bottom – 385A - Unfinished Optional Strikes – see page 39	
Dogging Feature	Hex key dogging standard	
Dogging Options	CD Cylinder Dogging	see page 48
	SD Special Center Case Dogging	see page 48
	LD Less Dogging	see page 48
Electric Options	LX Latchbolt Monitor Switch	see page 42
	RX Pushpad Monitor Switch	see page 42
	RX2 Double Pushpad Monitor Switch	see page 42
	EL Electric Latch Retraction	see page 43
	SS Signal Switch	see page 43
	CX Chexit Delayed Exit	see page 45
	ALK Alarm Exit Kit	see page 42
Miscellaneous Options	PN Pneumatic Latch Retraction	see page 48
	GBK Glass Bead Kit	see page 49
Fasteners & Sex Bolts (SNB)	Includes 1 3/4" (19mm) – 2 1/4" (57mm) Wood & Metal Doors Optional SNB available for device, see next page for quantities	
Latch Bolt	Deadlocking Top Bolt, 3/4" (19mm) throw Deadlocking Bottom Bolt, 1 1/2" (38mm) throw	
Device Centerline from Finished Floor	39 5/8" (1006 mm) Standard, Adjustable from 35 5/8" (905mm) to 49 5/8" (1260mm)	
Door Undercut	1/4" (7mm) maximum	
Center Case Dimensions	8" x 2 3/4" x 2 3/8" (203mm x 70mm x 60mm)	
Mechanism Case Dimensions	2 1/4" x 2 1/4" (57mm x 57mm)	
Top & Bottom Latch Case	4 1/2" x 2 1/8" x 1 1/2" (114mm x 54mm x 38mm)	
Vertical Rods	Round 2 piece adjustable rods Top rod adjustable from 6'8" (2027mm) to 8'4"(2533mm) Bottom rod adjustable 35 5/8" (905 mm) to 49 5/8" (1260 mm) Extension rod kits available for doors over 8'4" (2533mm)	
Projection	Pushbar Neutral – 3 13/16" (97 mm) Pushbar Depressed – 3 1/16" (78 mm)	

See page 53 for How to Order specification

VON DUPRIN® 9848/9948 Concealed Vertical Rod Device Standard Trim

	Exit only	Dummy Trim Pull when Dogged	Night Latch Key Retracts Latchbolt	Night Latch Key Retracts Latchbolt Optional Pull Required	Thumbturn Key Locks & Unlocks (Use with DT Trim)	Thumbturn Blank Escutcheon Always Operable (No Cylinder) (Use with DT Trim)
Product Description	9848EO 9948EO	9848DT 9948DT	9848NL 9948NL	9848NL-OP 9948NL-OP	9848TL 9948TL	9848TL-BE 9948TL-BE
Trim Description	—	990DT	990NL-R/V	110NL-MD	374T x 990DT	374T-BE x 990DT
Escutcheon Plate Size	—	3" x 14 ⁹ / ₁₆ " x ³ / ₃₂ " (76x360x2mm)	3" x 14 ⁹ / ₁₆ " x ³ / ₃₂ " (76x360x2mm)	—	2 ³ / ₄ " x 10 ³ / ₄ " x ²⁷ / ₃₂ " (70x273x21mm)	2 ³ / ₄ " x 10 ³ / ₄ " x ²⁷ / ₃₂ " (70x273x21mm)
Pull Center to Center	—	5 ¹ / ₂ " (140mm)	5 ¹ / ₂ " (140mm)	—	—	—
Projection	—	2" (51mm)	2" (51mm)	—	3 ¹ / ₄ " (83mm)	3 ¹ / ₄ " (83mm)
ANSI Function	01	02	03	03	11	—
Cylinder Type	—	—	Rim	Rim	1 ¹ / ₄ " Mortise	—
Optional Trim (See pages 32 – 34)	x990EO x992EO x994EO x996EO	x991K-DT x992L-DT x994L-DT x996L-DT x696DT x697DT	x991K-NL x992L-NL x994L-NL x996L-NL x696NL x697NL			
Optional #425 Sex Bolt Quantity for Device	6	2	2	6	2	2

	Lever Key Locks & Unlocks	Lever – Night Latch Key Retracts Latchbolt	Lever – Blank Escutcheon Always operable (No Cylinder)	Lever Dummy Trim Pull when Dogged
Product Description	9848L 9948L	9848L-NL 9948L-NL	9848L-BE 9948L-BE	9848L-DT 9948L-DT
Trim Description	996L-CV	996L-NL-CV	996L-BE-CV	996L-DT-CV
Escutcheon Plate Size	2 ³ / ₄ " x 10 ³ / ₄ " x ²⁷ / ₃₂ " (70x273x21mm)	2 ³ / ₄ " x 10 ³ / ₄ " x ²⁷ / ₃₂ " (70x273x21mm)	2 ³ / ₄ " x 10 ³ / ₄ " x ²⁷ / ₃₂ " (70x273x21mm)	2 ³ / ₄ " x 10 ³ / ₄ " x ²⁷ / ₃₂ " (70x273x21mm)
Pull Center to Center	—	—	—	—
Projection	2 ⁷ / ₈ " (73mm)	2 ⁷ / ₈ " (73mm)	2 ⁷ / ₈ " (73mm)	2 ⁷ / ₈ " (73mm)
ANSI Function	08	09	—	02
Cylinder Type	Rim	Rim	—	—
Optional Trim (See pages 32 – 34)	x992L x994L	x992L-NL x994L-NL	x992L-BE x994L-BE	x992L-DT x994L-DT
Optional #425 Sex Bolt Quantity for Device	2	2	2	2

For optional trims and functions see pages 32-34

VON DUPRIN® 9848-F/9948-F Concealed Vertical Rod Fire Device

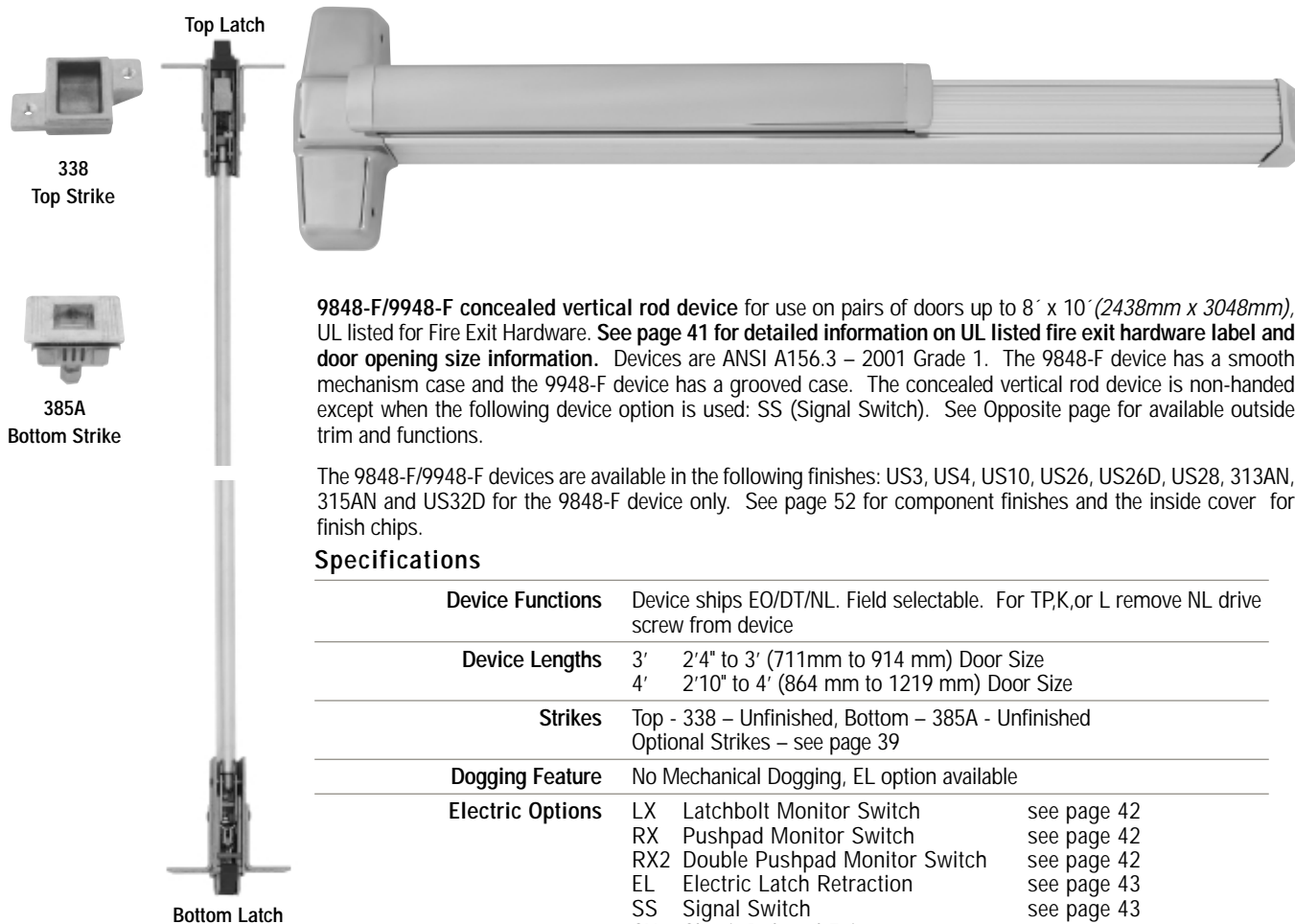

9848-F/9948-F concealed vertical rod device for use on pairs of doors up to 8' x 10' (2438mm x 3048mm), UL listed for Fire Exit Hardware. See page 41 for detailed information on UL listed fire exit hardware label and door opening size information. Devices are ANSI A156.3 – 2001 Grade 1. The 9848-F device has a smooth mechanism case and the 9948-F device has a grooved case. The concealed vertical rod device is non-handed except when the following device option is used: SS (Signal Switch). See Opposite page for available outside trim and functions.

The 9848-F/9948-F devices are available in the following finishes: US3, US4, US10, US26, US26D, US28, 313AN, 315AN and US32D for the 9848-F device only. See page 52 for component finishes and the inside cover for finish chips.

Specifications

Device Functions	Device ships EO/DT/NL. Field selectable. For TPK, or L remove NL drive screw from device	
Device Lengths	3' 2'4" to 3' (711mm to 914 mm) Door Size	4' 2'10" to 4' (864 mm to 1219 mm) Door Size
Strikes	Top - 338 – Unfinished, Bottom – 385A - Unfinished Optional Strikes – see page 39	
Dogging Feature	No Mechanical Dogging, EL option available	
Electric Options	LX Latchbolt Monitor Switch	see page 42
	RX Pushpad Monitor Switch	see page 42
	RX2 Double Pushpad Monitor Switch	see page 42
	EL Electric Latch Retraction	see page 43
	SS Signal Switch	see page 43
	CX Chexit Delayed Exit	see page 45
	ALK Alarm Exit Kit	see page 42
Miscellaneous Options	PN Pneumatic Latch Retraction	see page 48
	GBK Glass Bead Kit	see page 49
Fasteners & Sex Bolts (SNB)	Includes 1 ¾" (19mm) – 2 ¼" (57mm) Wood & Metal Doors Optional SNB available for device, see next page for quantities Optional SLM Blocking Pkg for wood doors with SLM blocking SNB required for wood doors, unless SLM Blocking Pkg specified	
Latch Bolt	Deadlocking Top Bolt, ¾" (19mm) throw Deadlocking Bottom Bolt, 1 ½" (38mm) throw	
Device Centerline from Finished Floor	39 5/8" (1006 mm) Standard, Adjustable from 35 5/8" (905mm) to 49 5/8" (1260mm)	
Door Undercut	¼" (7mm) maximum	
Center Case Dimensions	8" x 2 ¾" x 2 ¾" (203mm x 70mm x 60mm)	
Mechanism Case Dimensions	2 ¼" x 2 ¼" (57mm x 57mm)	
Top & Bottom Latch Case	4 ½" x 2 1/8" x 1 ½" (114mm x 54mm x 38mm)	
Vertical Rods	Round 2 piece adjustable rods Top rod adjustable from 6'8" (2027mm) to 8'4"(2533mm) Bottom rod adjustable 35 5/8" (905 mm) to 49 5/8" (1260 mm) Extension rod kits available for doors over 8'4" (2533mm)	
Projection	Pushbar Neutral – 3 13/16" (97 mm) Pushbar Depressed – 3 1/16" (78 mm)	

See page 53 for How to Order specification

	Exit only	Dummy Trim Pull when Dogged (Not recommended for Fire Device)	Night Latch Key Retracts Latchbolt	Night Latch Key Retracts Latchbolt Optional Pull Required	Thumbturn Key Locks & Unlocks (Use with DT Trim)	Thumbturn Blank Escutcheon Always Operable (No Cylinder) (Use with DT Trim)
Product Description	9848EO-F 9948EO-F	---	9848NL-F 9948NL-F	9848NL-OP-F 9948NL-OP-F	9848TL-F 9948TL-F	9848TL-BE-F 9948TL-BE-F
Trim Description	---	990DT	990NL-R/V	110NL-MD	374T x 990DT	374T-BE x 990DT
Escutcheon Plate Size	---	3" x 14 ³ / ₁₆ " x ³ / ₃₂ " (76x360x2mm)	3" x 14 ³ / ₁₆ " x ³ / ₃₂ " (76x360x2mm)	---	2 ³ / ₄ " x 10 ³ / ₄ " x ²⁷ / ₃₂ " (70x273x21mm)	2 ³ / ₄ " x 10 ³ / ₄ " x ²⁷ / ₃₂ " (70x273x21mm)
Pull Center to Center	---	5 ¹ / ₂ " (140mm)	5 ¹ / ₂ " (140mm)	---	---	---
Projection	---	2" (51mm)	2" (51mm)	---	3 ¹ / ₄ " (83mm)	3 ¹ / ₄ " (83mm)
ANSI Function	01	02	03	03	11	---
Cylinder Type	---	---	Rim	Rim	1 ¹ / ₄ " Mortise	---
Optional Trim (See pages 32 – 34)	x990EO x992EO x994EO x996EO	x991K-DT x992L-DT x994L-DT x996L-DT x696DT x697DT	x991K-NL x992L-NL x994L-NL x996L-NL x696NL x697NL			
#425 SNB optional-HMD Req. WD w/o SLM Pkg.	6	2	2	6	2	2

	Lever Key Locks & Unlocks	Lever – Night Latch Key Retracts Latchbolt	Lever – Blank Escutcheon Always operable (No Cylinder)	Lever Dummy Trim Pull when Dogged (Not recommended for Fire Device)
Product Description	9848L-F 9948L-F	9848L-NL-F 9948L-NL-F	9848L-BE-F 9948L-BE-F	---
Trim Description	996L-CV	996L-NL-CV	996L-BE-CV	996L-DT-CV
Escutcheon Plate Size	2 ³ / ₄ " x 10 ³ / ₄ " x ²⁷ / ₃₂ " (70x273x21mm)	2 ³ / ₄ " x 10 ³ / ₄ " x ²⁷ / ₃₂ " (70x273x21mm)	2 ³ / ₄ " x 10 ³ / ₄ " x ²⁷ / ₃₂ " (70x273x21mm)	2 ³ / ₄ " x 10 ³ / ₄ " x ²⁷ / ₃₂ " (70x273x21mm)
Pull Center to Center	---	---	---	---
Projection	2 ⁷ / ₈ " (73mm)	2 ⁷ / ₈ " (73mm)	2 ⁷ / ₈ " (73mm)	2 ⁷ / ₈ " (73mm)
ANSI Function	08	09	---	02
Cylinder Type	Rim	Rim	---	---
Optional Trim (See pages 32 – 34)	x992L x994L	x992L-NL x994L-NL	x992L-BE x994L-BE	x992L-DT x994L-DT
#425 SNB optional-HMD Req. WD w/o SLM Pkg.	2	2	2	2

For optional trims and functions see pages 32-34

VON DUPRIN® 9847/9947 Wood Door Concealed Vertical Rod Device

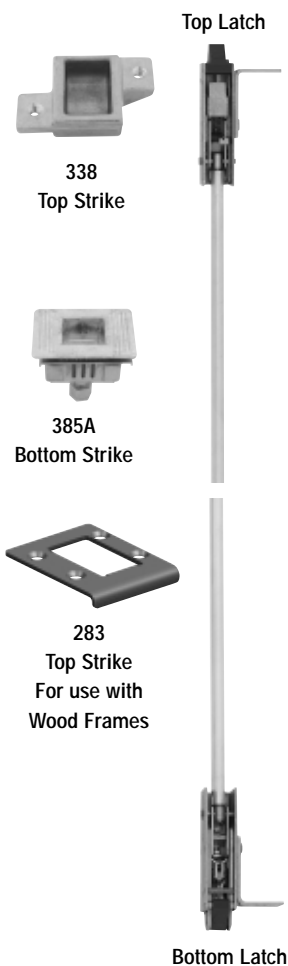

9847WDC/9947WDC concealed vertical rod device for use on single or double wood doors, UL listed for Panic Exit Hardware. Devices are ANSI A156.3 – 2001 Grade 1. The 9847WDC device has a smooth mechanism case and the 9947WDC device has a grooved case. The concealed vertical rod device is non-handed except when the following device options are used: SD (Special Dogging), or SS (Signal Switch). See Opposite page for available outside trim and functions.

The 9847WDC/9947WDC devices are available in the following finishes: US3, US4, US10, US26, US26D, US28, 313AN, 315AN and US32D for the 9847WDC device only. See page 52 for component finishes and the inside cover for finish chips.

Scalp Plate Device is furnished standard with an 8" (203mm) long scalp plate for easy access to rods.
Note: Do not use on pair of doors with 9975.

Specifications

Device Functions	Device ships EO/DT/NL. Field selectable. For TP,K,or L remove NL drive screw from device	
Device Lengths	3' 2'4" to 3' (711mm to 914 mm) Door Size 4' 2'10" to 4' (864 mm to 1219 mm) Door Size	
Strikes	Top - 338 – Unfinished, Bottom – 385A - Unfinished Optional Strikes – see page 39	
Dogging Feature	Hex key dogging standard	
Dogging Options	CD Cylinder Dogging	see page 48
	SD Special Center Case Dogging	see page 48
	LD Less Dogging	see page 48
Electric Options	LX Latchbolt Monitor Switch	see page 42
	RX Pushpad Monitor Switch	see page 42
	RX2 Double Pushpad Monitor Switch	see page 42
	EL Electric Latch Retraction	see page 43
	SS Signal Switch	see page 43
	CX Chexit Delayed Exit	see page 45
	ALK Alarm Exit Kit	see page 42
Miscellaneous Options	PN Pneumatic Latch Retraction	see page 48
	GBK Glass Bead Kit	see Page 49
	PL Pullman Latch	see page 49
Fasteners & Sex Bolts (SNB)	Includes 1 3/4" (19mm) – 2 1/4" (57mm) Wood & Metal Doors Optional SNB available for device, see next page for quantities	
Latch Bolt	Deadlocking Top & Bottom Bolt, 5/8" (16mm) throw	
Device Centerline from Finished Floor	39 5/8" (1006 mm) Standard, Adjustable from 35 5/8" (905mm) to 49 5/8" (1260mm)	
Door Undercut	1/4" (7mm) maximum	
Center Case Dimensions	8" x 2 3/4" x 2 3/8" (203mm x 70mm x 60mm)	
Mechanism Case Dimensions	2 1/4" x 2 1/4" (57mm x 57mm)	
Top & Bottom Latch Case	4 1/2" x 2 1/8" x 1 1/2" (114mm x 54mm x 38mm)	
Vertical Rods	Round 2 piece adjustable rods Top rod adjustable from 6'8" (2027mm) to 8'4"(2533mm) Bottom rod adjustable 35 5/8" (905 mm) to 49 5/8" (1260 mm) Extension rod kits available for doors over 8'4" (2533mm)	
Projection	Pushbar Neutral – 3 19/16" (97 mm) Pushbar Depressed – 3 1/16" (78 mm)	

See page 53 for How to Order specification

VON DUPRIN® 9847/9947 Wood Door Concealed Vertical Rod Device Standard Trim

	Exit only	Dummy Trim Pull when Dogged	Night Latch Key Retracts Latchbolt	Night Latch Key Retracts Latchbolt Optional Pull Required	Thumbturn Key Locks & Unlocks (Use with DT Trim)	Thumbturn Blank Escutcheon Always Operable (No Cylinder) (Use with DT Trim)
Product Description	9847WDC-EO 9947WDC-EO	9847WDC-DT 9947WDC-DT	9847WDC-NL 9947WDC-NL	9847WDC-NL-OP 9947WDC-NL-OP	9847WDC-TL 9947WDC-TL	9847WDC-TL-BE 9947WDC-TL-BE
Trim Description	—	990DT	990NL-R/V	110NL-WD	374T x 990DT	374T-BE x 990DT
Escutcheon Plate Size	—	3" x 14 ³ / ₁₆ " x ³ / ₃₂ " (76x360x2mm)	3" x 14 ³ / ₁₆ " x ³ / ₃₂ " (76x360x2mm)	—	2 ³ / ₄ " x 10 ³ / ₄ " x ²⁷ / ₃₂ " (70x273x21mm)	2 ³ / ₄ " x 10 ³ / ₄ " x ²⁷ / ₃₂ " (70x273x21mm)
Pull Center to Center	—	5 ¹ / ₂ " (140mm)	5 ¹ / ₂ " (140mm)	—	—	—
Projection	—	2" (51mm)	2" (51mm)	—	3 ¹ / ₄ " (83mm)	3 ¹ / ₄ " (83mm)
ANSI Function	01	02	03	03	11	—
Cylinder Type	—	—	Rim	Rim	1 ¹ / ₄ " Mortise	—
Optional Trim (See pages 32 – 34)	x990EO x992EO x994EO x996EO	x991K-DT x992L-DT x994L-DT x996L-DT x696DT x697DT	x991K-NL x992L-NL x994L-NL x996L-NL x696NL x697NL			
Optional #425 Sex Bolt Quantity for Device	6	2	2	6	2	2

	Lever Key Locks & Unlocks	Lever – Night Latch Key Retracts Latchbolt	Lever – Blank Escutcheon Always operable (No Cylinder)	Lever Dummy Trim Pull when Dogged
Product Description	9847WDC-L 9947WDC-L	9847WDC-L-NL 9947WDC-L-NL	9847WDC-L-BE 9947WDC-L-BE	9847WDC-L-DT 9947WDC-L-DT
Trim Description	996L-CV	996L-NL-CV	996L-BE-CV	996L-DT-CV
Escutcheon Plate Size	2 ³ / ₄ " x 10 ³ / ₄ " x ²⁷ / ₃₂ " (70x273x21mm)	2 ³ / ₄ " x 10 ³ / ₄ " x ²⁷ / ₃₂ " (70x273x21mm)	2 ³ / ₄ " x 10 ³ / ₄ " x ²⁷ / ₃₂ " (70x273x21mm)	2 ³ / ₄ " x 10 ³ / ₄ " x ²⁷ / ₃₂ " (70x273x21mm)
Pull Center to Center	—	—	—	—
Projection	2 ⁷ / ₈ " (73mm)	2 ⁷ / ₈ " (73mm)	2 ⁷ / ₈ " (73mm)	2 ⁷ / ₈ " (73mm)
ANSI Function	08	09	—	02
Cylinder Type	Rim	Rim	—	—
Optional Trim (See pages 32 – 34)	x992L x994L	x992L-NL x994L-NL	x992L-BE x994L-BE	x992L-DT x994L-DT
Optional #425 Sex Bolt Quantity for Device	2	2	2	2

For optional trims and functions see pages 32-34

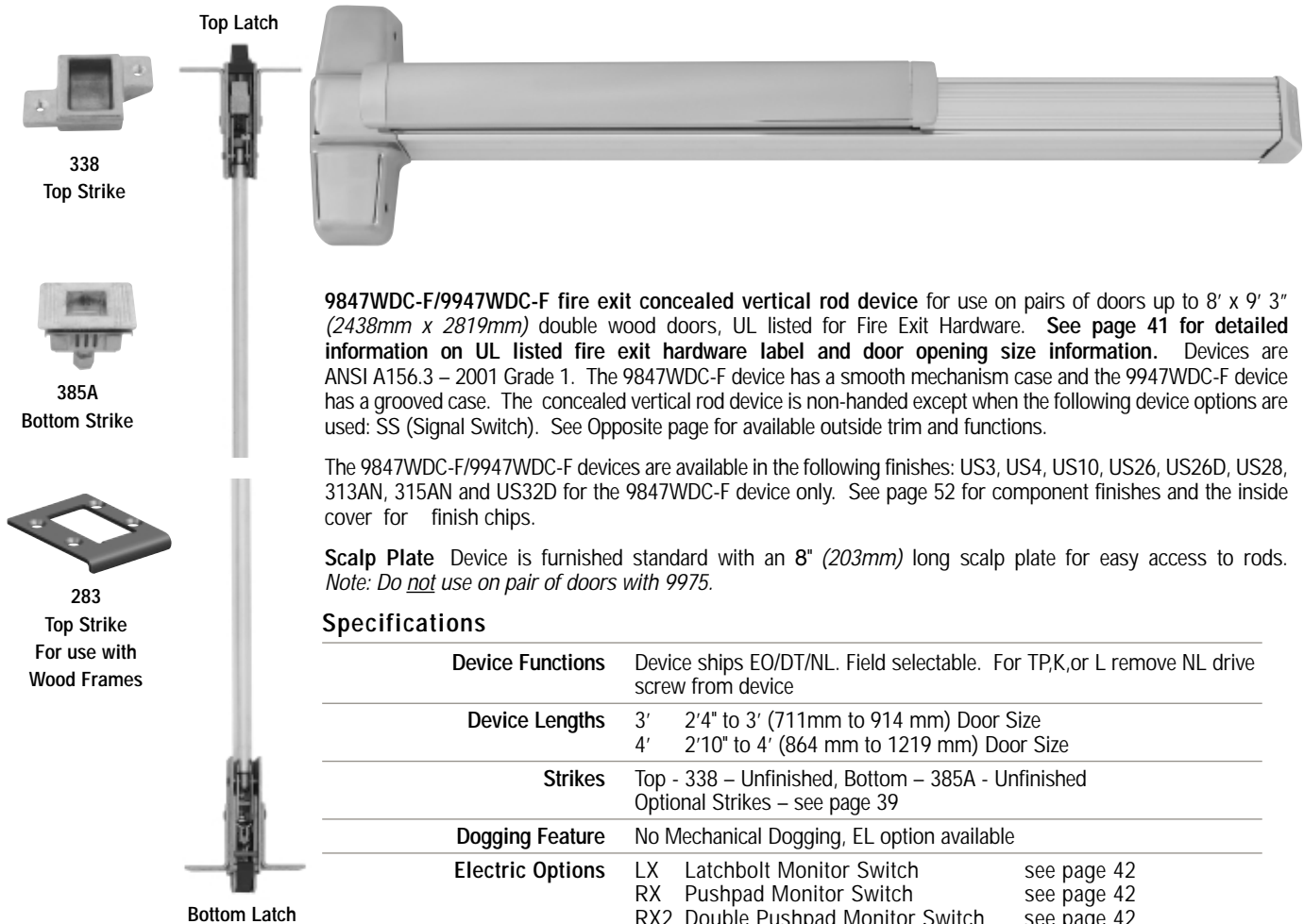

9847WDC-F/9947WDC-F fire exit concealed vertical rod device for use on pairs of doors up to 8' x 9' 3" (2438mm x 2819mm) double wood doors, UL listed for Fire Exit Hardware. See page 41 for detailed information on UL listed fire exit hardware label and door opening size information. Devices are ANSI A156.3 – 2001 Grade 1. The 9847WDC-F device has a smooth mechanism case and the 9947WDC-F device has a grooved case. The concealed vertical rod device is non-handed except when the following device options are used: SS (Signal Switch). See Opposite page for available outside trim and functions.

The 9847WDC-F/9947WDC-F devices are available in the following finishes: US3, US4, US10, US26, US26D, US28, 313AN, 315AN and US32D for the 9847WDC-F device only. See page 52 for component finishes and the inside cover for finish chips.

Scalp Plate Device is furnished standard with an 8" (203mm) long scalp plate for easy access to rods. Note: Do not use on pair of doors with 9975.

Specifications

Device Functions	Device ships EO/DT/NL. Field selectable. For TP,K, or L remove NL drive screw from device	
Device Lengths	3' 2'4" to 3' (711mm to 914 mm) Door Size	4' 2'10" to 4' (864 mm to 1219 mm) Door Size
Strikes	Top - 338 – Unfinished, Bottom – 385A - Unfinished Optional Strikes – see page 39	
Dogging Feature	No Mechanical Dogging, EL option available	
Electric Options	LX Latchbolt Monitor Switch	see page 42
	RX Pushpad Monitor Switch	see page 42
	RX2 Double Pushpad Monitor Switch	see page 42
	EL Electric Latch Retraction	see page 43
	SS Signal Switch	see page 43
	CX Chexit Delayed Exit	see page 45
	ALK Alarm Exit Kit	see page 42
Miscellaneous Options	PN Pneumatic Latch Retraction	see page 48
	LBR Less Bottom Rod	see page 49
	GBK Glass Bead Kit	see page 49
Fasteners & Sex Bolts (SNB)	Includes 1 3/4" (19mm) – 2 1/4" (57mm) Wood & Metal Doors Optional SNB available for device, see next page for quantities Optional SLM Blocking Pkg for wood doors with SLM blocking SNB required for wood doors, unless SLM Blocking Pkg specified	
Latch Bolt	Deadlocking Anti-friction Top & Bottom Bolt, 5/8" (16mm) throw	
Device Centerline from Finished Floor	39 5/8" (1006 mm) Standard, Adjustable from 35 5/8" (905mm) to 49 5/8" (1260mm)	
Door Undercut	1/4" (7mm) maximum	
Center Case Dimensions	8" x 2 3/4" x 2 5/8" (203mm x 70mm x 60mm)	
Mechanism Case Dimensions	2 1/4" x 2 1/4" (57mm x 57mm)	
Top & Bottom Latch Case	4 1/2" x 2 1/8" x 1 1/2" (114mm x 54mm x 38mm)	
Vertical Rods	Round 2 piece adjustable rods Top rod adjustable from 6'8" (2027mm) to 8'4"(2533mm) Bottom rod adjustable 35 5/8" (905 mm) to 49 5/8" (1260 mm) Extension rod kits available for doors over 8'4" (2533mm)	
Projection	Pushbar Neutral – 3 13/16" (97 mm) Pushbar Depressed – 3 1/16" (78 mm)	

See page 53 for How to Order specification

	Exit only	Dummy Trim Pull when Dogged (Not recommended for Fire Device)	Night Latch Key Retracts Latchbolt	Night Latch Key Retracts Latchbolt Optional Pull Required	Thumbturn Key Locks & Unlocks (Use with DT Trim)	Thumbturn Blank Escutcheon Always Operable (No Cylinder) (Use with DT Trim)
Product Description	9847WDC-EO-F 9947WDC-EO-F	---	9847WDC-NL-F 9947WDC-NL-F	9847WDC-NL-OP-F 9947WDC-NL-OP-F	9847WDC-TL-F 9947WDC-TL-F	9847WDC-TL-BE-F 9947WDC-TL-BE-F
Trim Description	---	990DT	990NL-R/V	110NL-WD	374T x 990DT	374T-BE x 990DT
Escutcheon Plate Size	---	3" x 14 ³ / ₁₆ " x ³ / ₃₂ " (76x360x2mm)	3" x 14 ³ / ₁₆ " x ³ / ₃₂ " (76x360x2mm)	---	2 ³ / ₄ " x 10 ³ / ₄ " x ²⁷ / ₃₂ " (70x273x21mm)	2 ³ / ₄ " x 10 ³ / ₄ " x ²⁷ / ₃₂ " (70x273x21mm)
Pull Center to Center	---	5 ¹ / ₂ " (140mm)	5 ¹ / ₂ " (140mm)	---	---	---
Projection	---	2" (51mm)	2" (51mm)	---	3 ¹ / ₄ " (83mm)	3 ¹ / ₄ " (83mm)
ANSI Function	01	02	03	03	11	---
Cylinder Type	---	---	Rim	Rim	1 ¹ / ₄ " Mortise	---
Optional Trim (See pages 32 – 34)	x990EO x992EO x994EO x996EO	x991K-DT x992L-DT x994L-DT x996L-DT x696DT x697DT	x991K-NL x992L-NL x994L-NL x996L-NL x696NL x697NL			
#425 SNB optional-HMD Req. WD w/o SLM Pkg.	6	2	2	6	2	2

	Lever Key Locks & Unlocks	Lever – Night Latch Key Retracts Latchbolt	Lever – Blank Escutcheon Always operable (No Cylinder)	Lever Dummy Trim Pull when Dogged (Not recommended for Fire Device)
Product Description	9847WDC-L-F 9947WDC-L-F	9847WDC-L-NL-F 9947WDC-L-NL-F	9847WDC-L-BE-F 9947WDC-L-BE-F	---
Trim Description	996L-CV	996L-NL-CV	996L-BE-CV	996L-DT-CV
Escutcheon Plate Size	2 ³ / ₄ " x 10 ³ / ₄ " x ²⁷ / ₃₂ " (70x273x21mm)	2 ³ / ₄ " x 10 ³ / ₄ " x ²⁷ / ₃₂ " (70x273x21mm)	2 ³ / ₄ " x 10 ³ / ₄ " x ²⁷ / ₃₂ " (70x273x21mm)	2 ³ / ₄ " x 10 ³ / ₄ " x ²⁷ / ₃₂ " (70x273x21mm)
Pull Center to Center	---	---	---	---
Projection	2 ⁷ / ₈ " (73mm)	2 ⁷ / ₈ " (73mm)	2 ⁷ / ₈ " (73mm)	2 ⁷ / ₈ " (73mm)
ANSI Function	08	09	---	02
Cylinder Type	Rim	Rim	---	---
Optional Trim (See pages 32 – 34)	x992L x994L	x992L-NL x994L-NL	x992L-BE x994L-BE	x992L-DT x994L-DT
#425 SNB optional-HMD Req. WD w/o SLM Pkg.	2	2	2	2

For optional trims and functions see pages 32-34

Knob and Thumbpiece Trim

	Knob Key Locks & Unlocks	Knob – Night Latch Key Retracts Latchbolt	Knob – Blank Escutcheon Always Operable (No Cylinder)	Knob – Dummy Trim Pull when Dogged	Thumbpiece Key Locks & Unlocks	Thumbpiece Blank Escutcheon Always Operable (No Cylinder)
Trim Description	991K	991K-NL	991K-BE	991K-DT	990TP	990TP-BE
Escutcheon Plate Size	2¾" x 10¾" x 27/32" (70x273x21mm)	2¾" x 10¾" x 27/32" (70x273x21mm)	2¾" x 10¾" x 27/32" (70x273x21mm)	2¾" x 10¾" x 27/32" (70x273x21mm)	2¾" x 10¾" x 27/32" (70x273x21mm)	2¾" x 10¾" x 27/32" (70x273x21mm)
Pull Center to Center	---	---	---	---	5½" (140mm)	5½" (140mm)
Projection	¾" (83mm)	¾" (83mm)	¾" (83mm)	¾" (83mm)	2" (51mm)	2" (51mm)
ANSI Function	08	09	---	02	05	05
Cylinder Type						
Rim or Vertical Rod Device	Rim	Rim	---	---	Rim	---
Mortise Lock Device	1¼" Mortise	1¼" Mortise	---	---	1¼" Mortise	---
#425 SNB optional-HMD Req. WD w/o SLM Pkg.	2	2	2	2	2	2
#825 SNB Req. WD w/o SLM Pkg. F Rim device ONLY	2	2	2	2	2	2
#425 SNB Req. w/ 499F	2	2	2	2	2	2

Lever Design Options



#01



#02



#03



#05



#06
Standard



#07



#12
Handed



#16



#17



#18





VON DUPRIN® 98/99™ Optional Lever Trim



996L Trim





The new 996L Breakaway™ trim has become the standard lever trim offering on the 98L/99L series devices. The 996L trim blends two successful Von Duprin designs; the look of the traditional 992L lever trim and the security and durability of the Von Duprin Breakaway™ design. The Breakaway™ design is especially effective in areas where vandalism to door hardware is a problem. The design intent is to discourage costly repairs from becoming necessary. The Breakaway™ feature is not available on the NL (night-latch) or DT (dummy trim) versions.

Optional Lever Trims – 992

	Lever Key Locks and Unlocks 	Lever – Night Latch Key Retracts Latchbolt 	Lever – Blank Escutcheon Always Operable (No Cylinder) 	Lever – Dummy Trim Pull when Dogged (Not recommended for Fire Device) 
Trim Description	992L	992L-NL	992L-BE	992L-DT
Escutcheon Plate Size	2¾" x 10¾" x 27/32" (70x273x21mm)	2¾" x 10¾" x 27/32" (70x273x21mm)	2¾" x 10¾" x 27/32" (70x273x21mm)	2¾" x 10¾" x 27/32" (70x273x21mm)
Pull Center to Center	--	--	--	--
Projection	27/8" (73mm)	27/8" (73mm)	27/8" (73mm)	27/8" (73mm)
ANSI Function	08	09	--	02
Cylinder Type				
Rim or Vertical Rod Device	Rim	Rim	--	--
Mortise Lock Device	1¼" Mortise	1¼" Mortise	--	--





The 992L trim series provides the traditional Von Duprin escutcheon design. Special versions available for doors of over 2 ¼" (57mm) thicknesses. Additionally available in an RX and E-locking/unlocking version.

Optional Lever Trims – 994





	Lever Key Locks and Unlocks 	Lever – Night Latch Key Retracts Latchbolt 	Lever – Blank Escutcheon Always Operable (No Cylinder) 	Lever – Dummy Trim Pull when Dogged (Not recommended for Fire Device) 
Trim Description	994L	994L-NL	994L-BE	994L-DT
Escutcheon Plate Size	2¾" x 9¼" x 27/32" (70x235x21mm)	2¾" x 9¼" x 27/32" (70x235x21mm)	2¾" x 9¼" x 27/32" (70x235x21mm)	2¾" x 9¼" x 27/32" (70x235x21mm)
Pull Center to Center	--	--	--	--
Projection	27/8" (73mm)	27/8" (73mm)	27/8" (73mm)	27/8" (73mm)
ANSI Function	08	09	--	02
Cylinder Type				
Rim or Vertical Rod Device	Rim	Rim	--	--
Mortise Lock Device	1¼" Mortise	1¼" Mortise	--	--

VON DUPRIN® 98/99™ Exit Rim Device

Optional Lever Trims – 696/697

	Dummy Trim Pull when Dogged (Not recommended for Fire Device) 	Dummy Trim Pull when Dogged (Not recommended for Fire Device) 	Night Latch Key Retracts Latchbolt 	Night Latch Key Retracts Latchbolt 
Trim Description	696DT	697DT	696NL	697NL
Escutcheon Plate Size	1 $\frac{5}{8}$ " x 1 $\frac{1}{2}$ " x $\frac{3}{16}$ " (41x343x5mm)	1 $\frac{5}{8}$ " x 1 $\frac{1}{2}$ " x $\frac{3}{16}$ " (41x343x5mm)	1 $\frac{5}{8}$ " x 1 $\frac{1}{2}$ " x $\frac{3}{16}$ " (41x343x5mm)	1 $\frac{5}{8}$ " x 1 $\frac{1}{2}$ " x $\frac{3}{16}$ " (41x343x5mm)
Pull Center to Center	5 $\frac{1}{2}$ " (140mm)	5 $\frac{1}{2}$ " (140mm)	5 $\frac{1}{2}$ " (140mm)	5 $\frac{1}{2}$ " (140mm)
Projection	2 $\frac{1}{8}$ " (52mm)	3" (76mm)	2 $\frac{1}{8}$ " (52mm)	3" (76mm)
ANSI Function	02	02	03	03
Cylinder Type				
Rim or Vertical Rod Device	--	--	Rim	Rim
Mortise Lock Device	--	--	1 $\frac{1}{4}$ " Mortise	1 $\frac{1}{4}$ " Mortise
#425 SNB optional-HMD Req. WD w/o SLM Pkg.	2	2	2	2
#825 SNB Req. WD w/o SLM Pkg.	2	2	2	2
#425 SNB Req. w/ 499F	2	2	2	2

Optional Lever Trims – 696/697

	Thumbpiece Key Locks & Unlocks 	Thumbpiece Key Locks & Unlocks 	Thumbpiece - Blank Escutcheon Always Operable (No Cylinder) 	Thumbpiece - Blank Escutcheon Always Operable (No Cylinder) 
Trim Description	696TP	697TP	696TP-BE	697TP-BE
Escutcheon Plate Size	1 $\frac{5}{8}$ " x 1 $\frac{1}{2}$ " x $\frac{3}{16}$ " (41x343x5mm)	1 $\frac{5}{8}$ " x 1 $\frac{1}{2}$ " x $\frac{3}{16}$ " (41x343x5mm)	1 $\frac{5}{8}$ " x 1 $\frac{1}{2}$ " x $\frac{3}{16}$ " (41x343x5mm)	1 $\frac{5}{8}$ " x 1 $\frac{1}{2}$ " x $\frac{3}{16}$ " (41x343x5mm)
Pull Center to Center	5 $\frac{1}{2}$ " (140mm)	5 $\frac{1}{2}$ " (140mm)	5 $\frac{1}{2}$ " (140mm)	5 $\frac{1}{2}$ " (140mm)
Projection	2 $\frac{1}{8}$ " (52mm)	3" (76mm)	2 $\frac{1}{8}$ " (52mm)	3" (76mm)
ANSI Function	05	05	05	05
Cylinder Type				
Rim or Vertical Rod Device	Rim	Rim	--	--
Mortise Lock Device	1 $\frac{1}{4}$ " Mortise	1 $\frac{1}{4}$ " Mortise	--	--
#425 SNB optional-HMD Req. WD w/o SLM Pkg.	2	2	2	2
#825 SNB Req. WD w/o SLM Pkg.	2	2	2	2
#425 SNB Req. w/ 499F	2	2	2	2

Operation Options

Lever and Knob Operations

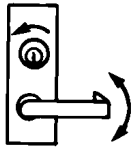

Standard operation, key locks and unlocks lever or knob. e.g., 996L (Classroom)

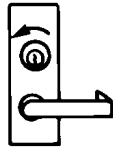

Night latch, key retracts latch bolt. Lever or knob is rigid. Use NL suffix, e.g. 996LNL. (Storeroom)

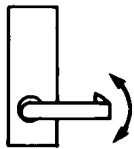

Blank escutcheon, lever or knob always active. Use BE suffix, e.g., 996L-BE. (Passage)

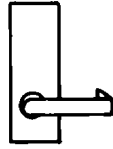

Dummy trim, lever or knob rigid for pull operation. Use DT suffix, e.g., 996L-DT.

374T/376T Series Thumbturn Control (Shown with 990DT Trim)



Standard operation, key locks and unlocks thumbturn. Optional operation, key unlocks thumbturn, re-locks when key is removed. This operation is created by changing the cylinder plate included with control. Use 1¼" mortise cylinder with a straight cam. Schlage cam reference B502-191.

HL6 Exit Device Trim Option



Von Duprin and Glynn-Johnson have collaborated on an exit device trim that answers the problem of accessibility and performance. Using the Von Duprin 98/9975 mortise lock exit device along with the Glynn-Johnson HL6 Push/Pull latch, Ingersoll-Rand has created an exit device with mortise lock durability that utilizes a fully ADA compliant Pull paddle trim. The 98/9975HL device is available in all standard architectural finishes and can be found in the Von Duprin device price list for easy ordering.

Vandal Resistant Trim

VR910 & VR914 Series

Features:

- Stainless Steel construction, 11 gage (0.120" thick)
- Thru-bolts and rugged mounting screws for maximum fastening strength.
- 10-24 screws supplied with VR910 & VR914 models.
- Built-in lock protector prevents vandalism to mortise latchbolt (available on certain models).
- Extra-tough stainless steel cylinder collar prevents pipe wrench or similar tool from damaging cylinder. Tapered design prevents side impacts from transferring directly to cylinder. Collar spins freely.
- Furnished with mounting screws for door thicknesses of 1¾" to 2¼"
- Finish: US32D
- VR910 grip coated in black plastisol for softer touch and resilience to temperature extremes. Grip designed for comfortable operation.
- VR914 grip in all stainless steel.
- Meets ANSI/BHMA 156.13, Trim Security Test and California State Accessibility Standards Title 24.
- 1½" (38mm) clearance from grip to door
- 1⅞" (48mm) total projection from door
- Consult IVES catalog for specification/ordering information.



Model	For Use With	Size
VR910DT & VR914DT	98/99 Rim or Vert. Rod Device	5¼" (133mm) w x 11" (279mm) h
VR910NL & VR914NL	98/99 Rim or Vert. Rod Device	5¼" (133mm) w x 11" (279mm) h
VR910M-DT & VR914M-DT	9875/9975 Mortise Device	7¼" (184mm) w x 11" (279mm) h
VR910M-NL & VR914M-NL	9875/9975 Mortise Device	7¼" (184mm) w x 11" (279mm) h

VON DUPRIN® 98/99™ CM993 and PRO993 Exit Trim

The Von Duprin Computer Managed CM993 Exit Trim is a stand-alone, battery-powered exit trim for use on doors where an exit device is required for egress. The CM993 is designed to be used with Von Duprin 98/99™ Rim and Vertical Rod exit devices for unmatched access control and ease of use. It can be programmed with LockLink™ or LockLink™ Express access control management software. The same software can also manage the Schlage CM Locks and the Locknetics Universal Controllers, which provide intelligent access control for electrified or battery-powered products such as magnets, strikes and cabinet locks.

Multiple users, Multiple access points. Multiple credential. One way to manage them.

Provides Unmatched Access Control

- Manages up to 1,000 users and provides audit trail for last 1,000 events
- SmarTime feature allows for time functionality:
 - 16 time zones
 - 16 time schedules
 - 32 holidays
 - first person in
 - time expiration
 - time activation
- Full-swipe mag stripe card reader for maximum readability and reliability
- Optional audit trail of mechanical key override
- Optional auto card updating feature disables a lost or stolen card when the reissued card is presented at the lock
- LED status indicators

Easy To Retrofit... Easy To Operate And Architecturally Designed For New Construction

- Directly retrofits existing trim
- Fits doors from 1 5/8" to 2 1/4" thick
- Comes with Schlage Everest 1 1/4" cylinder, but can adapt to other existing key systems
- LockLink software that programs the locks is Windows®-based and menu-driven. It can be operated with minimal training.



For use with Von Duprin 98/99™ Series Exit Devices including Rim, Surface Vertical, Concealed Vertical and Three-Point latching models. (Not for use with mortise devices).

NOT FOR USE WITH CHEXIT DEVICES

Conversion to New Card System Not Necessary

- Our exit device trims most likely work with your existing mag card and HID prox cards

Von Duprin Programmable PRO993 Exit Trim For Manual Programming

- Manually program up to 120 keycodes right at the trim
- Similar mechanical features as CM993
- Complements Schlage PRO and Locknetics PRO series products



CM993 – MGK – 06 – LH – KD – 695 – EXT



1. Select Model



CM993 Computer managed exit trim

PRO993 Manually programmed exit trim

2. Select Access Credential Option (CMs only)



KPI
Keypad iButton Reader



IBO
iButton Reader



MGK
Mag Card Reader Keypad iButton Reader



MGI
Mag Card Reader iButton Reader



PXX
HID prox Reader Keypad iButton Reader



PXI
HID prox Reader iButton Reader

3. Select Lever



#03



#06
Standard



#17

4. Select Handing

RH Right Hand

LH Left Hand

Note: Handing is field-reversible

5. Select Key Cylinder Option

KD Schlage Everest Cylinder

LC Less Cylinder

Note: Master keyed cylinders order separately

6. Select Finish:

605 Bright Brass

612 Satin Bronze

613 Oil-Rubbed Bronze

625 Bright Chrome

626 Satin Chrome (Standard)

695 Duranodic Dark Bronze

7. Select Trim Options

ATK Audit trail of mechanical key override, includes ATR (Requires computer programming).

T3 ABA Track 3 Mag Card Reader (ABA Track 2 is standard for MGI and MGK Series only).

EXT is now standard. Specify if for interior use.

Mag Card Reader for exterior use (for MGI and MGK Series only).

Select Credentials

IBA	iButton (adhesive backed)
IBF	iButton on Fob
MAG1	Magnetic Stripe Card – Blank
MAG2	Magnetic Stripe Card – Pre-encoded
PRX1	Prox Card – Standard .070" thick
PRX2	Prox Card – Adhesive backed for photo application, .070" thick
PRX3	Prox Card – ISO – credit card size and thickness, .031" thick
PRX4	Prox Card – Dual Technologies, magnetic stripe and Prox, .031" thick
PF1	Prox Fob

Door Thickness State door thickness. Available from 1 3/8" to 2 3/4" in 1/8" increments

VON DUPRIN® 98/99™ Strike/Stile Information

DEVICE TYPE	STANDARD SINGLE DOOR			STANDARD DOUBLE DOOR			OPTIONAL SINGLE DOOR			OPTIONAL DOUBLE DOOR		
	STRIKE	TRIM/STILE		STRIKE w/MULLION*	TRIM/STILE		STRIKE	TRIM/STILE		STRIKE w/MULLION*	TRIM/STILE	
98/99	299	990/992 994/996	696/697	299 x 4954	990/992 994/996	696/697	1439 or 1410	3-13/16" (97mm)	3-13/16" (97mm)	299 x 5654 1408 x 5754	990/992 994/996	696/697
		4-1/2" (114mm)	4-3/8" (111mm)		4-7/8" (124mm)	4-3/4" (121mm)		4-7/16" (113mm)	4-1/4" (108mm)			
		4-1/16" (103mm)	3-15/16" (100mm)		4-7/16" (113mm)	4-1/4" (108mm)						
98-F/99-F	299F	4-1/2" (114mm)	4-3/8" (111mm)	499F x 9954	4-7/8" (124mm)	4-3/4" (121mm)	---	---	---	499F x 9854 KR9954	---	---
9875 9975	575	4-3/4" (121mm)	4-3/4" (121mm)	575-2	---	---	---	---	---	576A-576B	4-3/4" (121mm)	4-3/4" (121mm)
9875-F 9975-F	575	4-3/4" (121mm)	4-3/4" (121mm)	575-2	---	---	---	---	---	576A-576B	4-3/4" (121mm)	4-3/4" (121mm)
9857 9957	299 (Top) 299 (Middle) 304L/284-L (Bottom)	4-1/2" (114mm)	4-3/8" (111mm)	299 x 4954	4-7/8" (124mm)	4-3/4" (121mm)	1439 or 1410	3-13/16" (97mm)	3-13/16" (97mm)	299 x 4954	4-7/16" (113mm)	4-1/4" (108mm)
								4-1/16" (103mm)	3-15/16" (100mm)	1408 x 5754	3-13/16" (97mm)	3-13/16" (97mm)
								1606	4-7/16" (113mm)	4-1/4" (108mm)		
9857-F 9957-F	299F (Top) 299F (Middle) 304L (Bottom)	4-1/2" (114mm)	4-3/8" (111mm)	299F 499F x 9954 304L	4-7/8" (124mm)	4-3/4" (121mm)	---	---	---	---	---	---
	STRIKE	APPLICATION			TRIM/STILE		OPTIONAL STRIKE			APPLICATION	TRIM/STILE	
9827 9927 LATCH RETRACTION PL9827/PL9927 PULLMAN LATCH	299 (Top) 304L/248L-4 (Bottom)	Single Door			990/992 994/996	696/697	260U (Top) 385A (Bottom)			Single Door	990/992 994/996	696/697
					3-11/16" (94mm)	3-5/8" (92mm)					3-11/16" (94mm)	3-5/8" (92mm)
					Two Vertical Rod Devices						260U (Stainless) 385A (Bottom)	3-11/16" (94mm)
9827-F 9927-F	299 (Top) 304L (Bottom)	Vertical Rod with Mortise Lock Device			4-3/4" (121mm)	4-3/4" (121mm)	304L (Bottom)			Vertical Rod with Mortise Lock Device	4-3/4" (121mm)	4-3/4" (121mm)
9847 9947 9848 9948	338 (Top) 385A (Bottom)											
9847-F 9947-F 9848-F 9948-F	338 (Top) 385A (Bottom)											
		Vertical Rod with Mortise Lock Device			4-3/4" (121mm)	4-3/4" (121mm)				Vertical Rod with Mortise Lock Device	4-3/4" (121mm)	4-3/4" (121mm)
9847WDC 9947WDC	338 (Top) 385A (Bottom)	Single Door			4-1/4" (108mm)	4-1/4" (108mm)	304L			Single Door	4-1/4" (108mm)	4-1/4" (108mm)
		Two Vertical Rod Devices			4-1/4" (108mm)	4-1/4" (108mm)				Two Vertical Rod Devices	4-1/4" (108mm)	4-1/4" (108mm)
		Vertical Rod with Mortise Lock Device			4-3/4" (121mm)	4-3/4" (121mm)				Vertical Rod with Mortise Lock Device	4-3/4" (121mm)	4-3/4" (121mm)
9847WDC-F 9947WDC-F	338 (Top) 385A (Bottom)	Two Vertical Rod Devices			4-1/4" (108mm)	4-1/4" (108mm)	304L			Two Vertical Rod Devices	4-1/4" (108mm)	4-1/4" (108mm)

*Mullion information—refer to the General and Auxiliary catalog.

Strikes for rim devices

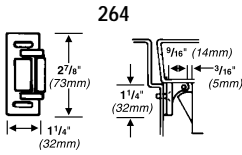

Projection 9/16" (14mm)

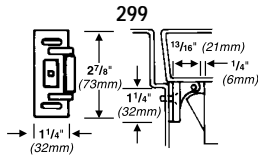

Projection 13/16" (21mm)

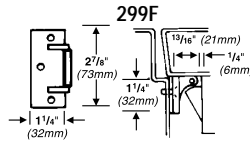

Projection 13/16" (21mm)

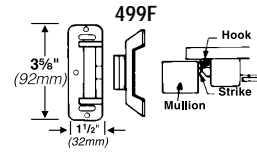

Projection 15/16" (24mm)

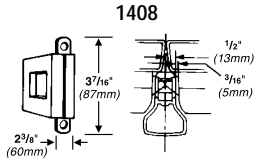

One per pair of doors

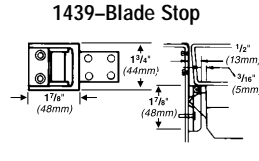

Projection 1/2" (13mm)

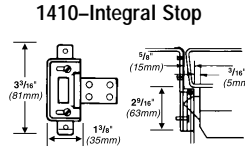

Projection 1/2" (13mm)

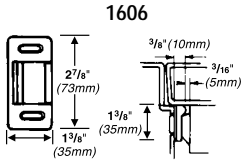

Projection 3/8" (10mm)
Panic Devices Only

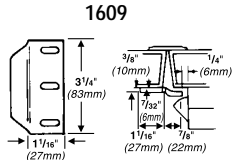

• Requires Coordinator
• For Fire Rated Application, consult factory

Strikes for vertical rod devices

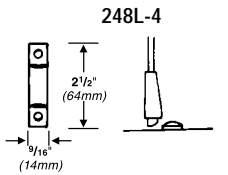

Projection 3/8" (10mm)

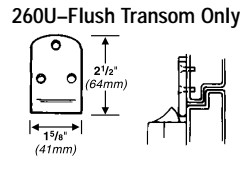

Projection 3/8" (10mm)
For Fire Rated Application, consult factory

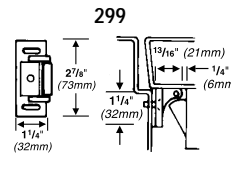

Projection 13/16" (21mm)

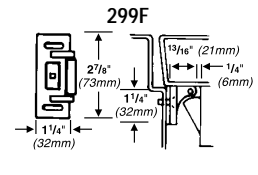

Projection 13/16" (21mm)

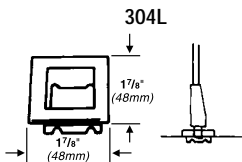

Mortise 13/16" (21mm)

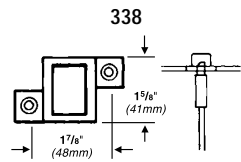

Mortise 5/8" (16mm)

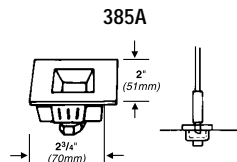

Mortise 2-1/2" (64mm)

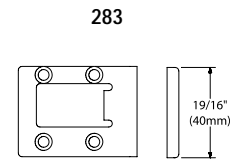

For use with WDC devices
when used with wood frames

Strikes for mortise lock devices

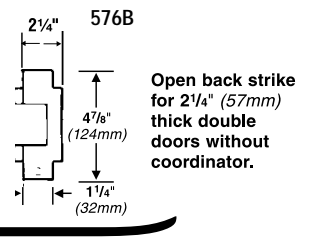
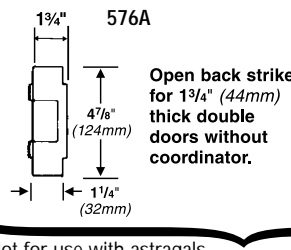
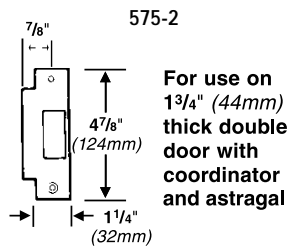
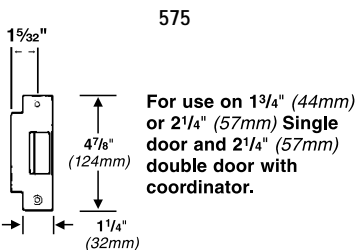

- Not for use with astragals
- Not for use on wood doors
- Acceptable for 90 minute pair of hollow metal doors

ANSI Grade, Type & Function

Function	Grade 1, Type 1	Grade 1, Type 2	Grade 1, Type 3	Grade 1, Type 7	Grade 1, Type 8	Grade 1, Type 9
01	98EO, 98EO-F 99EO, 99EO-F	9827EO, 9827EO-F 9927EO, 9927EO-F	9875EO, 9875EO-F 9975EO, 9975EO-F	9847WDC-EO & EO-F 9947WDC-EO & EO-F	9847EO, 9848EO-F 9947EO, 9947EO-F	9857EO, 9857EO-F 9957EO, 9957EO-F
02	98DT 99DT	9827DT 9927DT	9875DT 9975DT	9847WDC-DT* 9947WDC-DT	9848DT 9948DT	9857DT 9957DT
03	98NL, 98NL-F 99NL, 99NL-F	9827NL, 9827NL-F 9927NL, 9927NL-F	9875NL, 9875NL-F 9975NL, 9975NL-F	9847WDC-NL & NL-F 9947WDC-NL & NL-F	9847NL, 9847NL-F 9947NL, 9947NL-F	9857NL, 9857NL-F 9957NL, 9957NL-F
05	98TP, 98TP-F 99TP, 99TP-F	9827TP, 9827TP-F 9927TP, 9927TP-F	9875TP, 9875TP-F 9975TP, 9975TP-F	9847WDC-TP & TP-F 9947WDC-TP & TP-F	9847TP, 9847TP-F 9947TP, 9947TP-F	9857TP, 9857TP-F 9957TP, 9957TP-F
07	98TP-2, 98TP-F-2 99TP-2, 99TP-F-2	-- --	-- --	-- --	-- --	-- --
08*	98K, 98K-F 99K, 99K-F	9827K, 9827K-F 9927K, 9927K-F	9875K, 9875K-F 9975K, 9975K-F	9847WDC-K & WDC-K-F 9947WDC-K & WDC-K-F	9847K, 9847K-F 9947K, 9947K-F	9857K, 9857K-F 9957K, 9957K-F
08	98L, 98L-F 99L, 99L-F	9827L, 9827L-F 9927L, 9927L-F	9875L, 9875L-F 9975L, 9975L-F	9847WDC-L & WDC-L-F 9947WDC-L & WDC-L-F	9847L, 9847L-F 9947L, 9947L-F	9857L, 9857L-F 9957L, 9957L-F
09*	98K-NL, 98K-NL-F 99K-NL, 99K-NL-F	9827K-NL, 9827K-NL-F 9927K-NL, 9927K-NL-F	9875K-NL, 9875K-NL-F 9975K-NL, 9975K-NL-F	9847WDC-K-NL & WDC-K-NL-F 9947WDC-K-NL & WDC-K-NL-F	9847K-NL, 9847K-NL-F 9947K-NL, 9947K-NL-F	9857K-NL, 9857K-NL-F 9957K-NL, 9957K-NL-F
09	98L-NL, 98L-NL-F 99L-NL, 99L-NL-F	9827L-NL, 9827L-NL-F 9927L-NL, 9927L-NL-F	9875L-NL, 9875L-NL-F 9975L-NL, 9975L-NL-F	9847WDC-L-NL & WDC-L-NL-F 9947WDC-L-NL & WDC-L-NL-F	9847L-NL, 9847L-NL-F 9927L-NL, 9947L-NL-F	9857L-NL, 9857L-NL-F 9957L-NL, 9957L-NL-F
10*	98K-2, 98K-F-2 99K-2, 99K-F-2	-- --	-- --	-- --	-- --	-- --
10	98K-2, 98K-F-2 99K-2, 99K-F-2	-- --	-- --	-- --	-- --	-- --
11-12	-- --	9827TL, 9827TL-F 9927TL, 9927TL-F	-- --	9847WDC-TL & TL-F 9947WDC-TL & TL-F	9847TL, 9847TL-F 9947TL, 9947TL-F	-- --

*Device is Grade 1, 991K trim is Grade 2.

Dimensions

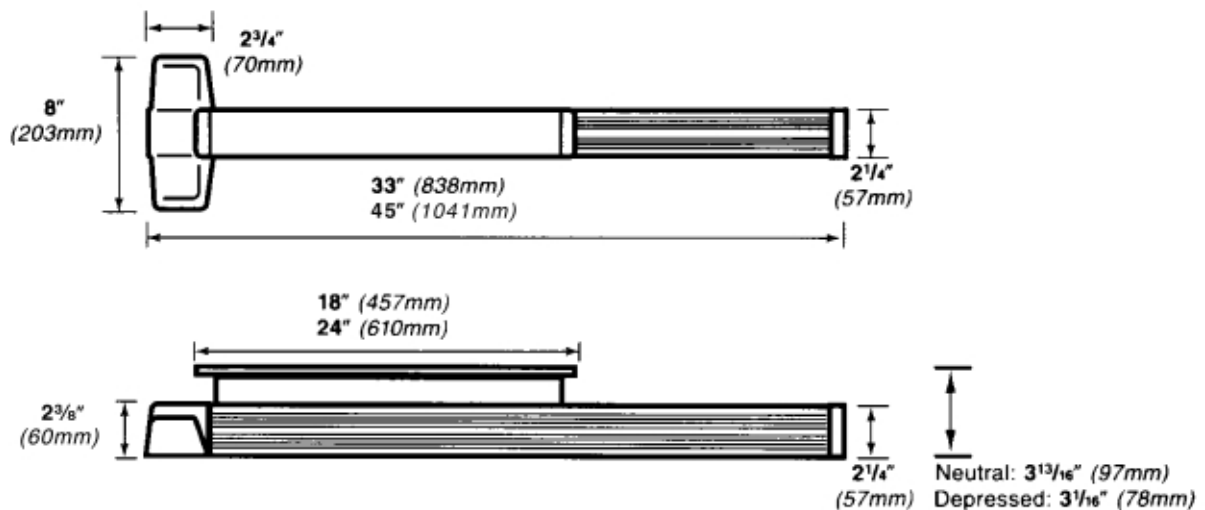

UL Listed Fire Exit Hardware Label and Opening Size

Exit Device	Door Material	Single Door	Double Door						
			With 9954 Mullion	With 9854 Mullion	With KR9954 Mullion	With KR9854 Mullion	VR/VR Same Direction	VR/Mortise Same Direction	VR/VR Double Egress
98-F 99-F	Metal	3 Hour 4' x 10'	3 Hour 8' x 10'	3 Hour 8' x 10'	3 Hour 8' x 8'	3 Hour 8' x 8'	---	---	---
9875-F 9975-F	Metal	3 Hour 4' x 10'	---	---	---	---	---	3 Hour 8' x 10'	---
9827-F 9927-F	Metal	---	---	---	---	---	90 Minute* 8' x 10'	3 Hour 8' x 10'	3 Hour 8' x 10'
9827LBR-F 9927LBR-F	Metal	---	---	---	---	---	90 Minute* 8' x 10'	---	3 Hour 8' x 10'
9857-F 9957-F	Metal	3 Hour 4' x 8'	3 Hour 8' x 8'	3 Hour 8' x 8'	3 Hour 8' x 8'	3 Hour 8' x 8'	---	---	---
9847-F 9947-F	Metal	---	---	---	---	---	90 Minute* 8' x 10'	3 Hour 8' x 10'	3 Hour 8' x 10'
9847LBR-F 9947LBR-F	Metal	---	---	---	---	---	90 Minute* 8' x 10'	---	3 Hour 8' x 10'
9848-F 9948-F	Metal	---	---	---	---	---	90 Minute* 8' x 10'	3 Hour 8' x 10'	3 Hour 8' x 10'

* Currently, no door manufacturers offer a listing over 90 minutes with doors swinging same direction.

Consult wood door manufacturers for current UL listings.

Alarm Kit – ALK



The ALK battery alarm kit is a simple yet effective way to deter unauthorized use of an opening. While the exit device is still a means of egress, the ALK kit contains an internal horn. When the touch bar is depressed, the horn sounds to provide an audible means of signaling that the opening has been violated. The alarm kit can be armed or disarmed by key. Thus allowing the exit device to be set in an armed or disarmed mode. The horn is rated at 85 decibel.

The key switch uses a standard 1¼" (32mm) mortise cylinder with a straight cam (Schlage Cam reference B502-191). The unit operates on one standard 9-volt alkaline battery. When the battery is weak, the horn will emit an intermittent low battery alert signal.

Also can be powered using the PS9 Power Supply. See PS9 for additional information.

Alarm kits are available with a choice of two switch kits, RX or LX. RX monitors the touchpad and is furnished standard. LX optional latch bolt monitoring is recommended for use with surface vertical rod exit devices. Specify ALK-LX.

Note: For latch bolt monitoring on a 98/9975 with ALK, specify a SS7500 lock. LX switch not available for 98/9975 devices.

The ALK is available in two styles, 33A/99ALK, grooved cover and 35A/98ALK, smooth cover.

The ALK includes "EMERGENCY EXIT ONLY. ALARM WILL SOUND" decal for application on door, or the SS push bar trim can be used instead of the door decal, specify SS push bar trim.

The ALK is available with 2 optional circuit boards. External Inhibit (EI) allows for the use of external switch to be used to arm, disarm and reset the alarm. Auto Reset (AR) rearms the alarm after a preset time. AR is available in three factory set times – 1½, 3 or 6 minutes.

To Order, Specify:

1. External Inhibit – ALK-EI
2. Auto Reset – ALK-AR3

When the ALK is used, standard dogging is removed. If cylinder dogging is required there are two choices. Special center case dogging is available or for 3' or 4' doors the ALK can be moved to the hinge side of the device and standard cylinder dogging can be added.

To Order, Specify:

1. Standard, 98NL ALK
2. Cylinder Dogging, CD98NL ALK
3. Special Center Case Dogging, SD98NL ALK

Minimum Door Opening Sizes on ALK Applications

Device	3' (914mm) Length	4' (1219mm) Length
98/98-F/99/99-F	2'9" (838mm)	3'3" (991mm)
9875/9875-F/9975/9975-F	2'9" (838mm)	3'3" (991mm)
9827/9827-F/9927/9927-F	2'8" (813mm)	3'2" (966mm)
9857/9857-F/9957/9957-F	2'8" (813mm)	3'2" (966mm)
9847/9847-F/9947/9947-F	2'8" (813mm)	3'2" (966mm)
9848/9848-F/9948/9948-F	2'8" (813mm)	3'2" (966mm)

Request to Exit — RX



The RX (Request to Exit) feature is used to signal the use of an opening. This device is equipped with one internal SPDT switch which monitors the pushpad.

The device can be connected to a security console, or may be used as a single door alarm when used with a horn and power supply. A continuous current electric transfer must be used for transferring power from the frame to the door.

The RX switch option should not be used to control a load, but as a signalling switch (0.5 amps. resistive maximum).

The RX switch is available in a low current (LC) switch. Most commonly used in computer operated monitoring systems.

To Order, Specify:

- Standard – Use prefix RX, example RX99EO
- Low Current – Use prefix RX-LC, example RX-LC98EO

Double Request to Exit — RX2

The RX2 feature uses 2 RX switches. Also available with the Low Current (LC) switch.

To Order, Specify:

- Standard – Use prefix RX2, example RX299EO
- Low Current – Use prefix RX2-LC, example RX2-LC98EO

Latch Bolt Monitoring — LX

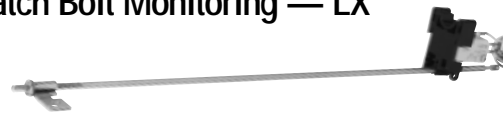

The LX feature is used to signal the use of an opening. This device is equipped with one internal SPDT switch which monitors the latch bolt.

The device can be connected to a security console, or may be used as a single door alarm when used with a horn and power supply. A continuous current electric transfer must be used for transferring power from the frame to the door.

The LX switch option should not be used to control a load, but as a signalling switch (0.5 amps. resistive maximum).

The LX switch is available in a low current (LC) switch. Most commonly used in computer operated monitoring systems.

To Order, Specify:

- Standard – Use prefix LX, example LX99EO
- Low Current – Use prefix LX-LC, example LX-LC98EO

Electrical Rating for all Switches:

- Standard – up to 0.5 Amp @ 24VDC Maximum
- Low Current (LC) - up to .05 Amp @ 24VDC Maximum

Note: All Switches can be either factory or field installed

Electric Latch Retraction — EL



The EL feature allows for the remote unlatching of exit devices. A control station operator can flip a switch to retract the latch bolt and immediately change an exit door to push-pull operation. A powerful, continuous duty solenoid retracts the latch bolt, either for momentary unlatching, or for extended periods of time. The EL feature is an alternative to manual dogging. If manual hex-key dogging is required, specify HD-EL. If cylinder dogging is required, the standard cylinder dogging is not available, but special center case dogging is available, specify SD-EL. SD-EL is not available on the 9875 or 9975 devices.

EL devices are also useful with automatic door operators, and may be applied to fire-rated applications when under the control of an **automatic fire alarm system**.

UL approved for Class II circuit applications.

The EL option does not include the power transfer from door to frame, the power supply, or the control operator. Refer to EPT-2 power transfer and the PS873 power supply.

The PS873 with the 871-2 option card is minimum option card required. Other option cards available for other functions, see PS873 power supply for additional information.

Solenoid Specifications:

- Continuous Duty — 24 VDC
- Current Inrush — 16 Amps
- Current Holding — 0.3 Amps

To order, specify:

- Standard — Use prefix EL, example EL99L.
- Hex Key dogging — Use prefix HD-EL, example HD-EL99L
- Special Center Case Dogging — Use prefix SD-EL, example SD-EL99L

Popular EL Application

Power Supply PS873-2

Electric Power Transfer EPT-2 or EPT-10

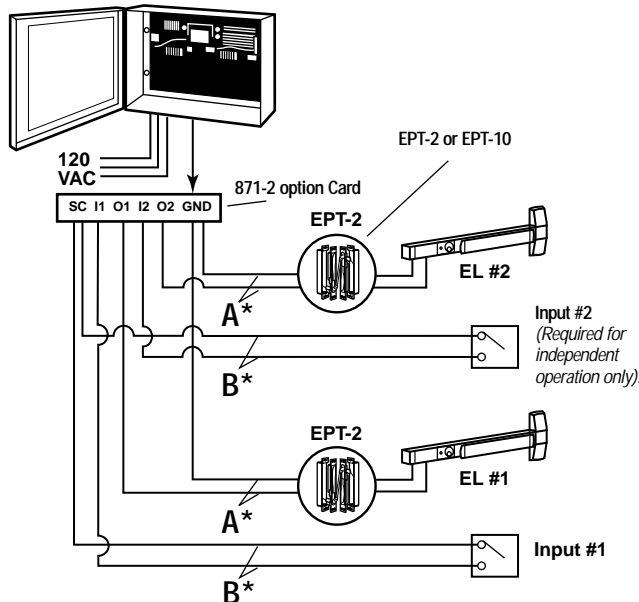

Signal Switch — SS



Monitors pushpad and latch bolt

The SS feature is used to signal the unauthorized use of an opening. This device is equipped with two internal SPDT switches. One switch monitors both the pushpad and the latch bolt assembly, making the latch bolt tamper resistant for positive security. An additional SPDT switch is connected to the 1 1/4" (32mm) mortise with straight cam for alarm "bypass." (Schlage cam reference B502-191). The device can be connected to a security console, or may be used as a single door alarm when used with a horn and power supply. A continuous current electric transfer must be used for transferring power from the frame to the door.

Pushpad reads:

"EMERGENCY EXIT ONLY – PUSH TO OPEN AND SOUND ALARM." Pushpad is only available in US32D finish with red silk-screened lettering.

The SS mortise lock device is furnished with both the signal switch device and the SS7500 mortise lock. The SS7500 mortise lock has the versatility and advantages of the 7500 lock with the addition of signalling functions to monitor latch bolt operation and the trim locking function. The SS7500 mortise lock is supplied standard with the SS mortise lock device.

To Order, Specify:

1. Prefix SS, example SS99L.
2. Handing Required, LHR or RHR.

Electrical Ratings:

Up to 2.0 AMPS @ 24VDC

Popular SS Application

Unauthorized use of this opening will activate the local horn.

The key switch permits inhibiting this system for authorized entry.

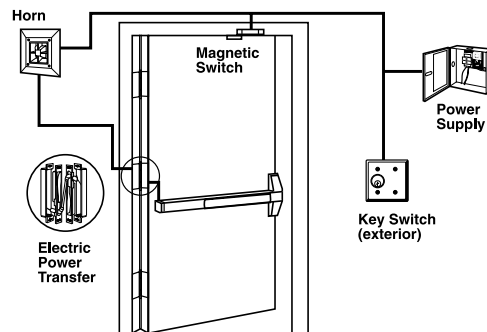

EL Device Wire Selection Size

A*	Run Length	EL Device w/EPT or Door Loop
	0-100 ft.	14 gauge
	100-200 ft.	12 gauge

A*	Run Length	EL Device w/Electric Hinge/Pivot
	0-75 ft.	14 gauge
	75-150 ft.	12 gauge

B*	Wire Selection	Switch Wire Size
	1200 ft. Max.	18 gauge

Electric Mortise Lock Device — E



The electric mortise lock device has all the versatility and advantages of the standard mortise lock device, plus the advantage of being electrically controlled by a remote switching device, an access control system or an automatic fire alarm system. The device features the E7500 mortise lock. The E7500 controls the locking of the outside trim. When unlocked, the door remains latched, preserving the fire rating of the door and making it particularly useful where codes permit locking but require unlocking during a fire emergency. The outside trim cylinder retracts the latch bolt for mechanical override, night latch function. Only available with TP, K or L functions.

The E7500 lock contains a SPDT signal to monitor the outside trim condition (locked or unlocked) and a second SPDT signal switch to monitor the latch bolt.

Standard Features:

- Field reversible handing
- 24 VDC continuous duty solenoid

Optional Features:

- Fail safe (locked when energized, unlocked when de-energized or during power failure). Specify with suffix "FS."
- Fail secure (unlocked when energized, locked when de-energized or during power failure). Specify with suffix "FSE"
- 24 VAC (with SO option)
- 12 VDC
- 12 VAC (with SO option)

Note: Some Fire codes will require "Fail Safe" (FS) operation for stairwell doors. Be sure to specify the correct operation for your application.

Electrical Specifications:

- Solenoid — .60 AMPS @ 12VDC
.30 AMPS @ 24VDC
- Each switch — Up to 2.0 AMPS @ 24VDC Maximum

The E option does not include the power transfer from door to frame, the power supply or the control operator. (Refer to EPT-10 and PS861 or PS873 power supply)

To Order, Specify:

1. Use prefix "E," example E9975.
2. FS or FSE
3. Voltage and current.

Electric Rim Device — E

The electric rim device provides remote locking and unlocking capabilities. A control station operator can flip a switch to lock or unlock the outside trim condition. The 24 VDC solenoid assembly contains a SPDT signal switch to monitor the outside trim condition (locked or unlocked), and a second SPDT signal switch to monitor the latch bolt.

The device is standard as fail safe (FS). When power is off, the trim is unlocked. The trim may then be relocked electrically by applying power. The device is field convertible for fail secure (FSE) applications.

The outside trim cylinder retracts the latch bolt for mechanical override, night latch function. Only available in TP, K or L function.

This feature does not include the power transfer from doors to frame, the power supply or control operator. Refer to the EPT-10 and PS861 or PS873 power supply.

NOTE: LX switch not required for E99 rim device when latch bolt monitoring is required. E99 Rim has standard latch bolt monitoring feature.

Specifications:

- Solenoid – 0.25 AMPS @ 24VDC
- Each switch – Up to 2.0 AMPS @ 24VDC Maximum

**UL listed FVSR SA163 panic hardware
And GXHX R4504(N) fire exit hardware**

To Order, Specify:

1. Use prefix "E," example E99TP.
2. Handing Required, LHR or RHR.

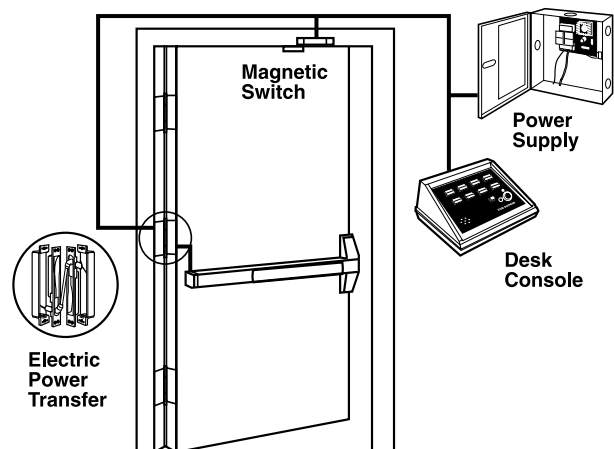

Electric Mortise Lock Device or Electric Rim Device

Adaptable for openings where continuous latching is required while the trim may be electrically locked or unlocked from a remote location—stairwells, exterior doors, etc.

Minimum System Requirements:

- PS861
- EPT-10

The Chexit®



Designed for use on delayed exit applications, the Chexit system is ideal for controlled areas.

All controls, auxiliary locking, local alarm, and remote signalling are self-contained in the Chexit, providing safe, secure, easy to install and simple to operate door control and exit hardware.

Chexit controlled exit device for use on Panic or Fire Exit hardware applications.

This concept in delayed exit systems combines life safety with the needs of security and meets all requirements of NFPA 101 for "Special Locking Arrangement."

The Chexit device includes decal for application on door.

"PUSH UNTIL ALARM SOUNDS.

DOOR CAN BE OPENED IN 15 SECONDS"

Solenoid Specifications:

- Continuous Duty – 24VDC
- Current Inrush – 16 amperes
- Current Holding – .3 amperes

Requires PS873 Power Supply

Request to Exit Switch:

Built into the device to detect when someone attempts to exit. Pushing the push pad when the device is armed will cause this switch to start an irreversible alarm cycle.

Nuisance Alarm:

When a Chexit is located in a public area, it can be desirable to limit false alarms. If the Nuisance Delay options are set to off, the device will go into alarm as soon as the push pad is touched (when armed). Turning the Nuisance Delay on will require the push pad to be pressed for 2 seconds before the Chexit goes into alarm. If the Nuisance Audible and Nuisance Delay are both on, the alarm will sound as soon as the push pad is pressed, but the alarm sequence will stop unless the push pad is held for 2 seconds or more.

Remote Alarm:

A set of relay contact are provided to give external alarm indication. These contact close when the device is in an irreversible alarm condition. These contact can be used to drive a horn, lamp, or other indicative device.

Key Switch:

The Key Switch provides the means to arm, disarm or reset the Chexit. The key can be removed in either the Arm or Disarm position.

Indicator Lamp:

The status of the Chexit can be determined by the indicator lamp. When the lamp is off, this indicates the device is disarmed and is functioning as a normal exit device (no delay). A continuously on lamp indicates the device has just been armed and as soon as the selectable rearm timer expires, the device will arm. A slow flashing lamp indicates the device is armed. A fast flashing indicator lamp indicates the device is in alarm.

Internal Horn:

Whenever the device is in alarm or the push pad is pressed the internal horn will sound. The volume level of this horn exceeds 85 db at 6 feet.

Door Position Input:

An external door position switch can be connected to the Chexit.

External Inhibit Input:

This optional input is provided to allow remote override of the Chexit in the armed condition. It also allows remote reset of the Chexit in an alarmed condition.

Fire Alarm Input:

This input disables the Chexit immediately upon a fire alarm.

Internal Auxiliary Lock:

The Auxiliary Lock is engaged when the Chexit is armed. The locking mechanism is specifically designed to hold securely even when the exit device is struck with forceful blows.

User Defineable Rearm Time:

The Rearm time is the amount of time after the device is activated before it arms. It is designed to give someone time to pass through the door before rearming occurs. Timing can be changed by the user for any time between 2 and 28 seconds in two second increments. There is also an infinite rearm setting that requires the use of an external door position switch. In this setting the door remains in the rearm mode until the door is closed. This can be useful on jet way doors in an airport.

Factory Defineable Delay Time:

Most jurisdictions allow 15 seconds of delay before allowing egress. In those cases where 15 seconds is not appropriate, Von Duprin can set the Chexit for any delay time between 0 and 60 seconds on 2 second increments. For delays greater than 15 seconds a letter from the local authority is required.

Electrical Accessories

Power Supplies



SERIES PS873

The series PS873 power supply is designed to operate a wide variety of electrical products. EL panics require 871-2 PCB minimum. The regulated output power is field selectable for either 24VDC @ 2 ampere or 12VDC @ 4 ampere. Standard input 120VAC @ 1.0 ampere or 240VAC @ 0.5 ampere available. Enclosure is 10" high x 12½" wide x 5" deep (254mm x 323mm x 127mm), gray with a hinged cover and constructed of heavy 19 gauge steel. Five ½" x ¾" (13mm x 19mm) knockout holes are provided for conduit connection. Terminal block will accept up to 12 gauge wire.

The PS873 can be ordered with three standard options: **Key lock** secures the cover to eliminate tampering and provides safety; **Battery backup** provides two hours backup power at full load during a A.C. power failure. Batteries will automatically recharge when failed power is restored. **Fire Alarm** provides input for a normally closed fire alarm contact. When the fire alarm contact is "open", power to locks or other component is removed. Restoring power is field selectable for automatic or manual.

Eight standard configurations:

PS873	Standard
PS873K	With keylock
PS873B	With battery
PS873BK	With battery and keylock
PS873FA	With fire alarm
PS873K-FA	With keylock and fire alarm
PS873B-FA	With battery and fire alarm
PS873BK-FA	With battery, keylock and fire alarm

The series PS873 is available with several optional circuit cards to provide system flexibility. The power supply will accept one or a combination of any two cards.

Factory or Field Installed Circuit Cards:

871-2, Two Zone controller provides two inputs and two outputs. Will operate one or two EL exit devices. Use suffix "-2" for factory installed, example PS873-2.

873-AL, Alarm function monitors 1 or 2 zones and provides alarm output, upon detecting a door in the open position. Delayed alarming is selectable from 5 to 75 seconds. Use suffix "-AL" for factory installed, example PS873-AL

873-AO, Auto Operator function coordinates the release of one or two locks and signals an auto-operator to open a door. Signaling the auto operator can be performed in two methods; by receiving a signal from a monitoring switch that the lock is unlatched, or upon expiration of a time delay triggered by a "RX" type input switch. Use suffix "-AO" for factory installed, example PS873-AO

873-SI, Security/Safety Interlock provide interlock function for two zones. When combined with a second 873-SI card, the inter-locking of groups are available in two, three or four zones. Safety interlock is available, consult factory for additional information. Use suffix "-SI" for factory installed, example PS873-SI

873-4TD, Four Zone controller with **Time Delay** provides four inputs and four outputs with time delay. Time delay is field selectable from 0 to 75 seconds, in intervals of 5 seconds. Will operate up to 4 EL devices. Use suffix "-4TD" for factory installed, example PS873-4TD

873-AC, Access Control provides supervision of one zone using an electromagnetic lock. Input signals required are: access control contact, motion detector contact, and motion detector override contact. FA, Fire Alarm option is required. Use suffix "-AC" for factory installed, example PS873-AC

Factory Installed Only Circuit Card

873-DE, Delayed Egress provides 15 second delay release from pushbar activation to electro-magnetic lock release. Ideal function for use with Locknetics electromagnetic locks, will operate two zones simultaneously. To operate two separate zones, a second 873-DE card is required. UL listed component, when used as part of a Von Duprin delayed egress system. Use suffix "- DE", example, PS873-DE.

Note: "DE" cards CANNOT be combined with any other optional cards.

Electrical Accessories

Power Supplies PS861 Power Supply

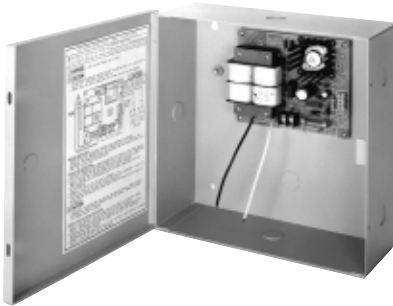

*Standard
UL Listed
Class 2, Power Supply
UL1012
UL1310*

The series PS861 power supply is designed for electric locking or monitoring on single or double door applications. The output power is field selectable for either 24 VDC @ 1 ampere or 12 VDC @ 2 ampere. Standard input 120 VAC @ 0.6 ampere and 240 VAC @ 3.0 ampere available. The terminal block will accept up to 14 gauge stranded wire.

The gray enclosure is 10" x 10" x 4" (254mm x 254mm x 102mm), has a hinged cover, and is constructed of heavy 19 gauge steel. Six 1/2" (13mm) knockout holes are provided for conduit connection.

Options include keylock cover or Battery Backup. The pair of batteries, which are sealed lead acid battery packs, will provide back-up power for three hours at full load or seven hours at half load. Batteries will automatically recharge when failed power is restored.

Four Models:

PS861	Standard supply
PS861K	Standard supply with keylock cover
PS861B	Battery backup
PS861FA	Fire Alarm
PS861BK	Battery backup and keylock cover
PS861BKFA	Battery backup and keylock cover with FA board (24VDC only)

PS9 Power Supply

The PS9 is an AC power supply that provides 9 VDC power to operate the ALK alarm kit. The unit will power one or two alarm kits. Included is a 9-volt sealed battery that provides backup power in case of an AC power failure.



Electrical Power Transfer — EPT Pneumatic Transfer – PNT

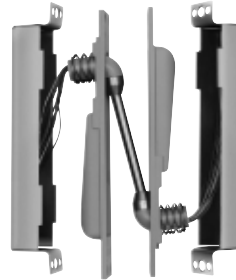

Electric Power Transfer provides a means of transferring electrical power from a door frame to the edge of a swinging door. The units are completely concealed when the door is in the closed position, and are ideally suited for installations involving abuse or heavy traffic.

Two models are available; EPT-2, two 18 gauge wires and EPT-10, ten 24 gauge wires. The EPT-2 and EPT-10 are U/L listed as "miscellaneous door accessory".

Pneumatic Controls

PNT-1 is available for pneumatic latch retraction exit devices. Appearance and dimensions are identical to EPT models.

UL Listed for use on fire doors

Door applications:

up to 5" butt hinges – 180° swing,
5 1/2" butt hinges – 130° swing,
6" butt hinges – 110° swing,
3/4" butt offset pivots 180° swing.

Not for use with swing clear hinges or center-hung pivots.

Finishes

SP28 (sprayed aluminum)
SP313 (sprayed duranodic).

Dimensions

Housing	9" x 1 1/4" x 1 5/8" (229mm x 32mm x 38mm)
EPT-2	Two 18 gauge wires, Up to 2 AMPS @ 24VDC, with a 16 AMPS Maximum Surge
EPT-10	Ten 24 gauge wires, Up to 1 AMPS @ 24VDC, with a 16 AMPS Maximum Surge
PNT-1	5/32" Tubing

To order, specify:

1. EPT-2, EPT-10 or PNT-1.
2. Finish, SP28 or SP313.

Pneumatic Controlled Exit Devices–PN



The PN feature provides remote latch bolt retraction in hazardous areas where electrically operated devices would not be permitted. The pneumatic solenoid will retract the latch bolt for momentary or prolonged periods. PN exit devices are particularly suited for use with automatic door operators. The PN feature is available on both Panic and Fire Exit Hardware devices.

The PN feature includes a special actuating linkage that gives building owners the option of mechanically or pneumatically dogging the exit device. If manual hex-key dogging is required, specify HD-PN (Dogging the device, whether mechanically or pneumatically, makes the device function as a push/pull unit and reduces the wear on its moving parts.) If cylinder dogging is required, the standard cylinder dogging is not available, but special center case dogging is available, specify SD-PN. SD-PN is not available on the 9875 or 9975 devices.

When activated pneumatically, the latch bolt(s) of the exit device retract in ½ to 1 ½ seconds. This pneumatic operation uses air pressure ranging from 50 to 100 pounds per square inch.

This product will function only when it is part of a pneumatic system (air compressor, air lines, pneumatic system, etc.). Contact LCN for correct control boxes

To Order, Specify:

- Standard — Use prefix PN, example PN99NL
- Hex Key Dogging — Use prefix HD-PN, example HD-PN99NL
- Special Center Case Dogging — Use prefix SD-PN, example SD-PN99NL

Double Cylinder – 2



Double cylinder features an inside key cylinder which locks or unlocks the outside trim and an outside key cylinder which retracts the latch bolt only (Night Latch Function). Available on rim or mortise lock device.

Rim requires two rim type cylinders. Mortise device requires 1 rim cylinder and 1 mortise cylinder 1¼" with a straight cam. (Schlage cam reference B502-191.)

Available functions are thumbpiece, knob or lever.

To Order, Specify:

1. Suffix-2 with device/trim number, example 99TP-2.
2. Handing required, LHR or RHR.

Less Dogging – LD

Less Dogging is available in all 98/99™ Panic Exit devices to remove the dogging option.

To Order, Specify:

- Use prefix LD, example LD99L

Special Center Case Dogging – SD



Special cylinder dogging in the center case is available for Chexit, EL, ALK panic devices to allow for mechanical push/pull operation. With this option, the latchbolt is held retracted and pushbar is still operable. Specify handing — RHR or LHR.

SD requires 1 ¼" (32mm) mortise cylinder with a straight cam. (Schlage cam reference B502-191.)

Note: Available on Rim and Vertical Rod Panic Exit Devices only.

To Order, Specify:

- Use prefix SD, example SD99L

Cylinder Dogging — CD



Cylinder dogging is available on all 98/99™ Panic Exit devices to replace the standard hex key dogging. Unit requires a standard 1¼" (32mm) mortise cylinder with a straight cam (Schlage Cam B502-191 reference).

To Order, Specify:

- Use prefix, CD, example CD99L

Cylinder Dogging Kit — CDK

For field conversion, a cylinder dogging conversion kit is available. Cannot be added to fire exit hardware.

Order: 33A/99CDK or 35A/98CDK, specify finish.

Hex Key Dogging Kit — HDK

For field conversion, a hex key dogging conversion kit is available. Cannot be added to fire exit hardware.

Order: 33A/99HDK or 35A/98HDK, specify finish.

Braille, Embossed and Knurled Touchpads



Braille touchpad is embossed with the message "CAUTION STAIRWELL" in braille and raised letters provides assistance to person with impaired vision. Letters are ½" (13mm) high and braille is #2, raised height is ⅜" (2mm). Other messages are available on special order, limited to 20 characters per line.

Embossed touchpad is embossed with the word "PUSH"
Knurled touchpad is to provide warning to person with impaired vision.

Vertical Rod and Latch Guard — RG-27

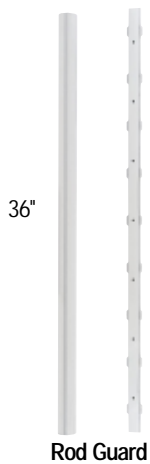

Series RG-27 Vertical Rod and Latch Guards protect the bottom rods of exit devices from the damaging impacts of carts or gurneys passing through doors. (If bottom rods become damaged, the exit device will not function as intended and can jeopardize the ability to exit safely during an emergency.)

In addition to protecting the vertical rod, the guard provides a smooth, unobstructed surface so the door can be pushed open easily with the bumpers of a wheelchair. The latch guard portion is 10" high. The standard latch guard features a 45° ramp. The extended latch guard offers a continuous ramp in 3' or 4' widths.

All stainless steel construction in US32D finish. Latch guards can cover latches as large as 1 1/4"W x 10"H x 1 7/8" projection.

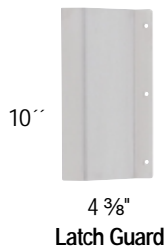

Models

- RG0** — Rod guard only (Projection 1 3/16").
- RG-27** — Rod and latch guard.
- RG-27-3** — 3' (914mm) Rod Guard and Extended Latch Guard.
- RG-27-4** — 4' (1219mm) Rod Guard and Extended Latch Guard.

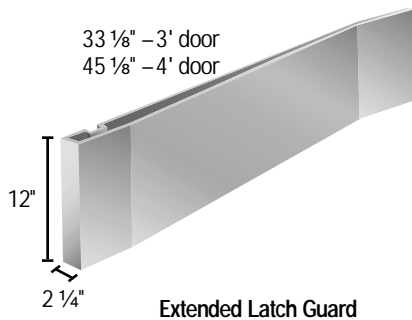

- LGO** — Latch guard only.
- LGO-3** — 3' (914mm) Extended latch guard only.
- LGO-4** — 4' (1219mm) Extended latch guard only.

Note: Not for use on wood fire doors

To Order, Specify:

1. Model number.
2. Handing (except on RG0).
3. Door material if other than Hollow Metal.
4. Optional sex bolt mounting available.

Less Bottom Rod – LBR

LBR option is available, using a spring loaded auxiliary latch bolt installed in the lower door edge. When exposed to heat the auxiliary latch bolt releases, keeping the doors in alignment and closed during a fire. UL listed 3 hours on hollow metal doors double egress, 90 minute swinging same direction, and 20 minutes wood doors (consult wood door manufacturer). Fits door stiles as narrow as 3 5/8".

LBR devices must be ordered in pairs or must be used in conjunction with an approved automatic or constant latching flush bolt.

Pullman Latch – PL

When PL is specified the standard latches are replaced with pullman style latches. Pullman latches are always extended and are most commonly used in conjunction with electric strikes and LBR-less bottom rod application. Not available with Fire rated devices. Not recommended where security is of the utmost since latches do not deadlock.

Glass Bead Kit – GBK

Glass bead conversion kits are available for all 98/99™ Series devices for use on doors with raised glass beads. Each kit consists of 1/4" (6mm) shim sets. GBK for Surface Vertical Rod ships with 1/8" shims for rod guides.

To order, specify:

1. 99GBK
2. Device type (Rim, Mortise, Surface Vertical Rod, Concealed Vertical Rod)
3. Wood Door, when used with Concealed Vertical Rod

997 Cover Plate Kit

For 99 rim device, kit contains inside and outside plates for hinge stile cutouts, an inside plate for the lock stile, and necessary screws. Plates are designed to cover cutouts required by most existing exit device installations. Specify finish.

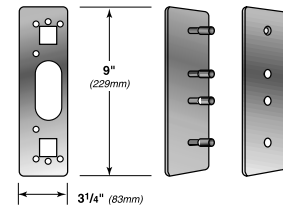

Dummy Pushpad



The 330 dummy pushpad is designed as a companion unit for all 99 devices. The 350 dummy pushpad is a companion unit for all 98 devices. The pushpad is rigid or nonfunctioning. A push/pull operation can be accomplished by using 990DT, 996DT trim or any Ives Pull.

The 330/350 can be equipped with a functional pushpad and will accommodate an RX switch. Specify RX-330. May also be equipped with the RX2, double RX switch. Specify RX2-330

To order, specify:

1. 330 or 350.
2. Size 3' or 4' (914mm or 1219mm)
3. Finish, US3, US4, US10, US26, US26D, US28, 313AN, 315AN, 350 Only US32D.

Cylinders

Cylinders are not furnished with device or trim and must be specified when ordering. Refer to trim pages for cylinder type.



Mortise — 3215 (Schlage B502-191 cam)

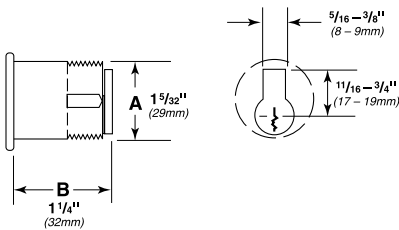

Rim 3216

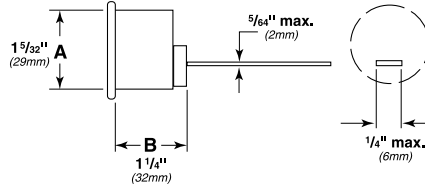

Dogged (Inverted) Cam

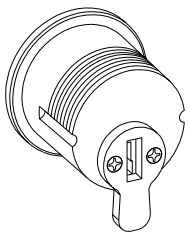

For Cylinder Dogging

Undogged Cam
(Standard Operations)

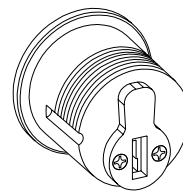

For Standard Trim Functions

Door Handing

Left Hand-Reverse
Orientation

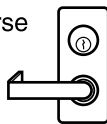

Right Hand-Reverse
Orientation

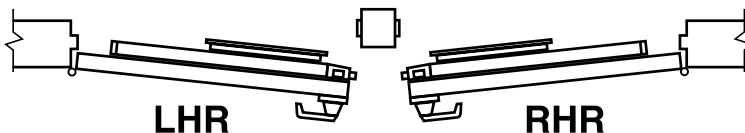
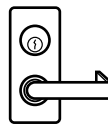

(Left hand reverse)

(Right hand reverse)

Outside

Popular Double Door Applications

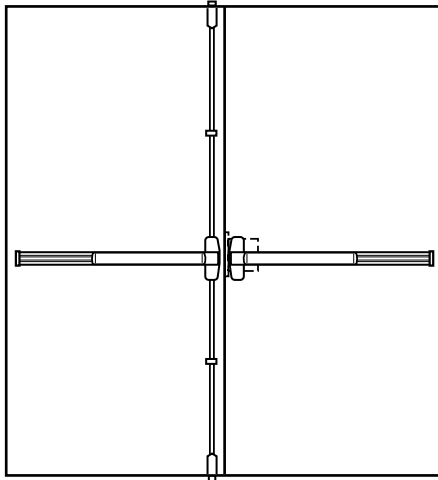

Mortise lock and surface mounted or Concealed Vertical rod device combination—same direction

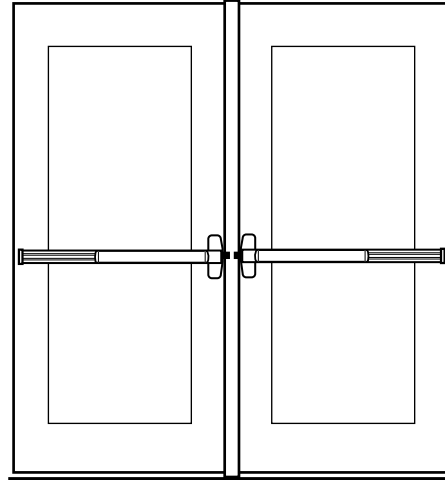

Two rim devices with mullion—same direction

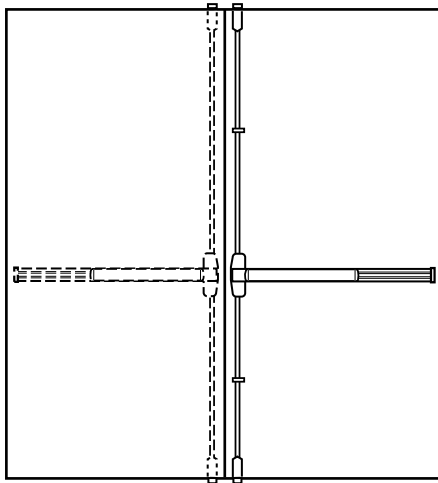

Two vertical rods—double egress

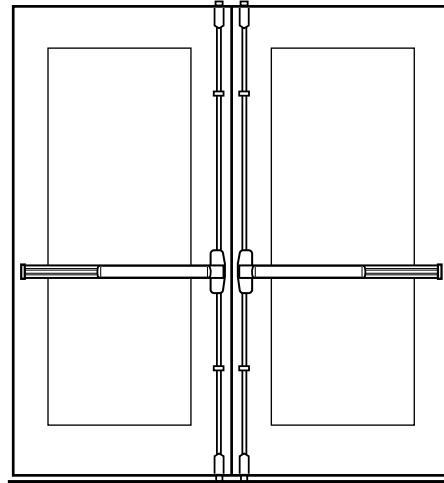

Two surface mounted vertical rod devices—same direction
(do not use with overlapping astragal)

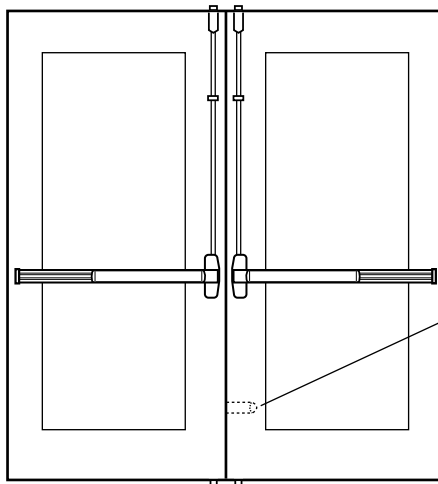

Two FEH vertical rods with auxiliary fire latch—LBR option

Auxiliary Fire Latch

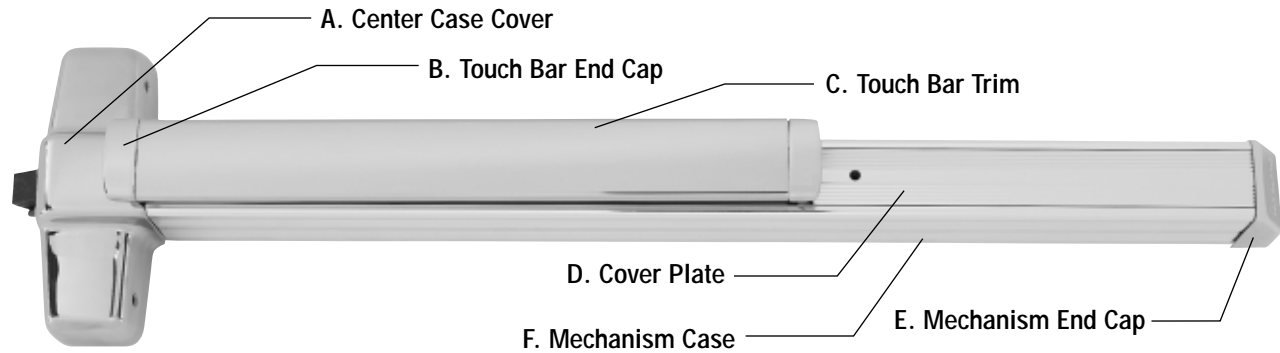

Finishes

Color	US Number	BHMA Number	A, B, E	C	D & F
Brass, Polished	US3	605	Plated	Brass, Polished US3, 605	Buffed Anodized
Brass, Satin	US4	606	Plated	Brass, Dull US4, 606	Anodized
Bronze, Satin	US10	612	Plated/Anodized	Bronze, Dull US10, 612	Anodized
Chrome, Polished	US26	625	Plated	Stainless Steel, Polished US32, 629	Buffed Anodized
Chrome, Satin	US26D	626	Plated	Stainless Steel, Satin US32D, 630	Anodized
Stainless Steel, Satin*	US32D	630	Stainless Steel	Stainless Steel, Satin US32D, 630	Anodized
Aluminum, Anodized	US28	628	Powder Coat	Stainless Steel, Satin US32D, 630	Anodized
Duranodic Dark Bronze	313AN	710	Powder Coat	Brown Wrinkle Powder Coat	Anodized
Black Anodized	315AN	–	Powder Coat	Black Wrinkle Powder Coat	Anodized

Special Finishes

Color	US Number	BHMA Number	A, B, E	C	D & F
Bronze, Oil-Rubbed Satin	US10B	613	Plated	Bronze, US10B, 613	Anodized
Powder Coat	RAL #	–	Powder Coat	Stainless Steel, Satin US32D, 630	Powder Coat
Bronze, Polished	US9	611	Plated	Bronze, Polished US9, 611	Buffed Anodized
Nickel, Satin	US15	619	Plated	Stainless Steel, Satin US32D	Anodized

Touch Bar Trim Options:

Knurled

Embossed "Push"

Braille, US32D Only, Embossed "Caution Stairwell"

SS, US32D Only, Red silk screen lettered "EMERGENCY EXIT ONLY – PUSH TO OPEN AND SOUND ALARM."

**US32D Finish—available on Series 98 only*

Nomenclature – How To Order

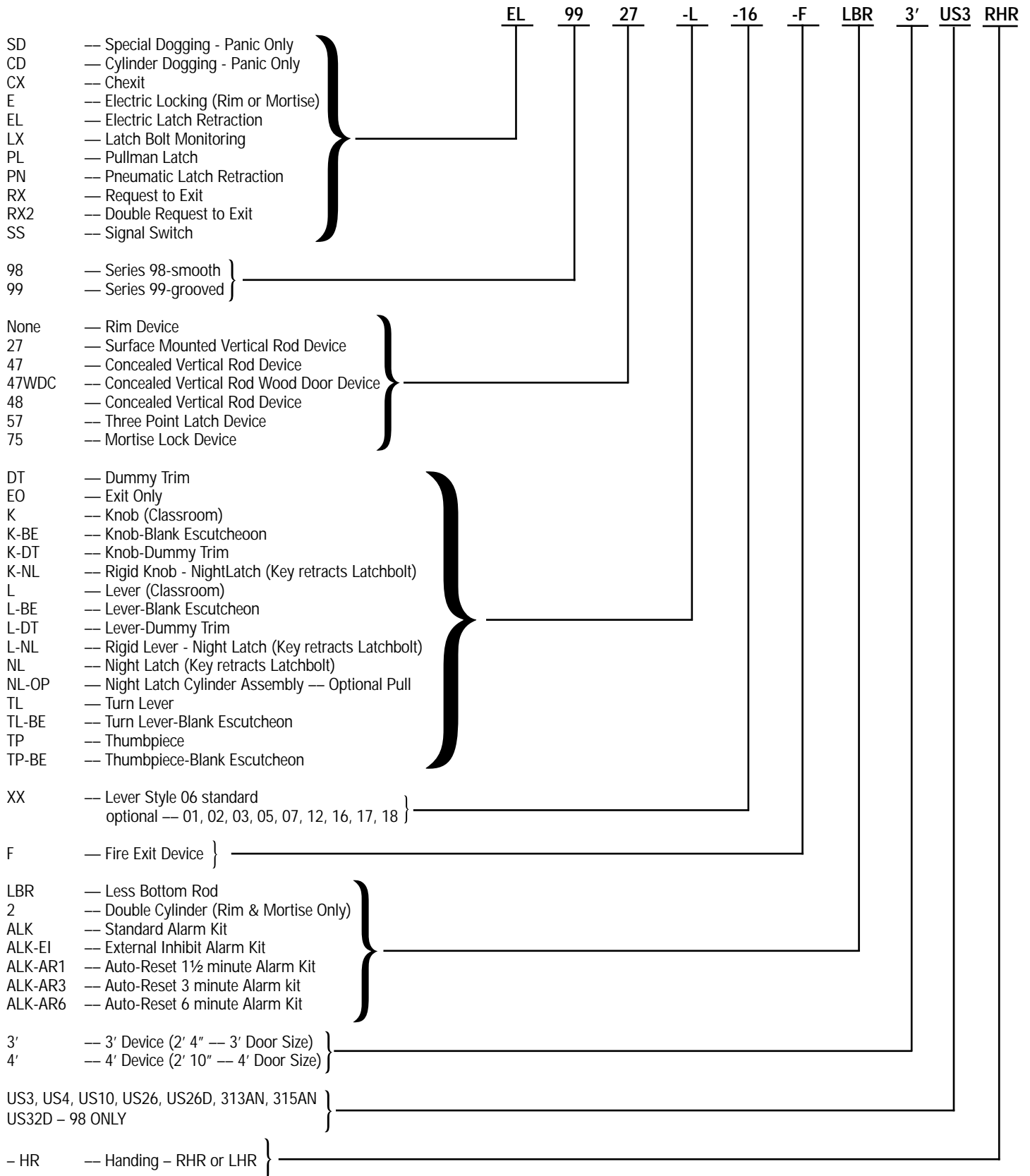

VON DUPRIN®

98/99™ Series Exit Devices

International Offices

Canada / Latin America

IR Security & Safety
1076 Lakeshore Road East
Mississauga, Ontario,
L5E 1E4, Canada
(905) 403-1800
(905) 278-1413 FAX
(877) 590-4734

North-East Asia

IR Security & Safety
23/F, 625 King's Road
Northpoint, Hong Kong
+(852) 2235-0600
+(852) 2565-1409 FAX

South-East Asia / Australia / NZ

IR Architectural Hardware Ltd.
P.O. Box 19-347
437 Rosebank Road,
Avondale, Auckland, New Zealand
+64 (0) 9-829-0550
+64 (0) 9-829-0552 FAX
www.irarchitecturalhardware.co.nz

Mexico

IR Security & Safety
Blvd. Centro Industrial No. 11
Puentas de Vigag, Tlalnepantla
Estado de Mexico, 54070 Mexico
+525-5-8503-6614

Europe / Middle-East / Africa

IR Security & Safety Ltd.
Bescot Crescent
Walsall, West Midlands WS1 4DL
United Kingdom
+44 (0)1922 707400
+44 (0)1922 646303 FAX
www.irsecurityandsafety.co.uk



Visit Von Duprin on the web
www.vonduprin.com
or contact an
IR Security & Safety Consultant
1-877-840-3621



VON DUPRIN

Administrative Offices
2720 Tobey Dr.
Indianapolis, IN 46219
317-613-8944
317-613-8302 Fax

Customer Service
800-999-0408
800-999-0328 Fax

Technical Support
888-371-7331
317-613-8509 Fax

An **IR** Ingersoll Rand business